

# Orthopaedic

Bone Cutting Forceps

Bone Rongeurs Bone

Holding Forceps Bone

Holding Clamps Plaster

Spreaders and Shears

Bone Curettes Bone

Levers Retractors

Dissecting Forceps and

Hooks Raspatories, Burr

and Rugines Osteotomes,

Chisels and Gouges Wire

Cutters and Pliers

Accessories Mallets

Raspatories, Files and

Punches Pushers,

Impactors and Skids

Elevators Retractors and

Bone Levers Saws, Shears

and Knives Screw and

Plate Instruments Pins

Sterile Kirschner and

Arthrodesis Wires

Extremities Instruments

and Sets Shoulder

Instruments



**TETRA**  
INDUSTRIES

# Bone Cutting Forceps

## McIndoe Bone Cutting Forcep

Lightweight, compound action, angled jaw with prismatic points

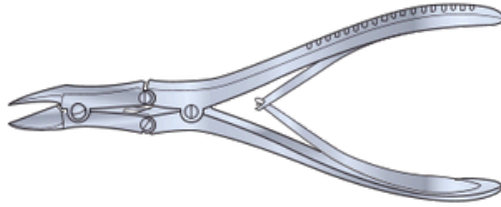

Code	Description
SC-OR/13b	165mm long
SC-OR/13c	191mm long

## Liston Box Joint Bone Cutting Forcep

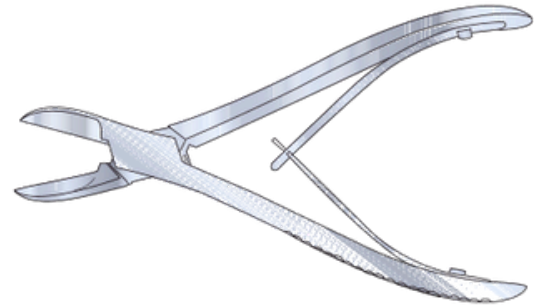

### Straight

Code	Description
SC-OR/032	140mm long
SC-OR/033	200mm long
SC-OR/027	220mm long

### Angled

Code	Description
SC-OR/061	170mm long
SC-OR/062	220mm long

## Liston Screw Joint Bone Cutting Forcep

With fluted handle

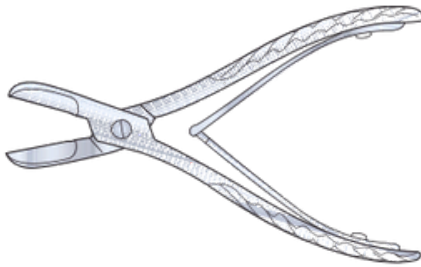

### 150mm long

Code	Description
SC-OR/24	Straight
SC-OR/24a	Angled

### 200mm long

Code	Description
SC-OR/26	Straight

### 180mm long

Code	Description
SC-OR/25	Straight
SC-OR/25a	Angled

### 230mm long

Code	Description
SC-OR/27	Straight

## Screw Joint Bone Cutting Forcep

Straight

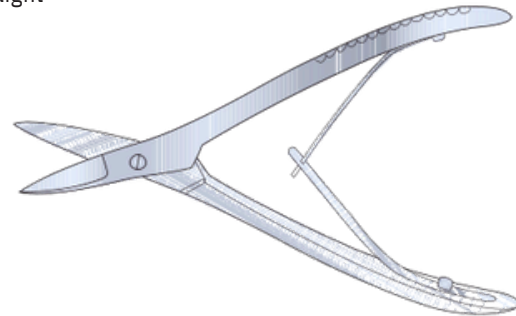

Code	Description
SC-OR/030	160mm long

## Liston Compound Action Bone Cutting Forcep

Straight, for heavy duty

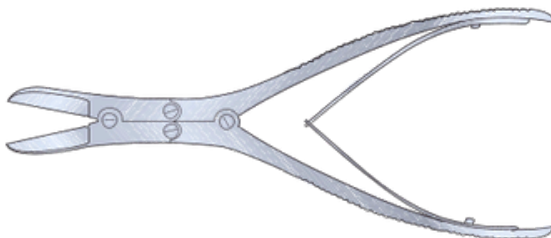

Code	Description
SC-OR/27a	305mm long
SC-OR/27b	300mm long
SC-OR/27c	190mm long

## Ruskin-Liston Bone Cutting Forcep

Compound action, fine

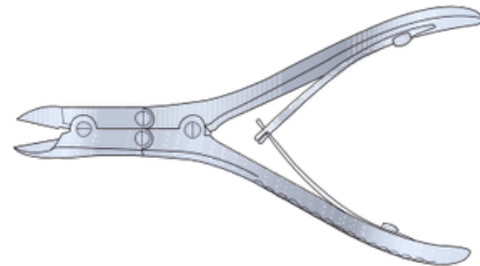

### Straight

Code	Description
SC-OR/057	140mm long
S C O R /074 SC-	145mm long
OR/073	190mm long

### Angled

Code	Description
SC-OR/063	190mm long



## Ward Bone Cutting Forceps

Slightly angled on flat

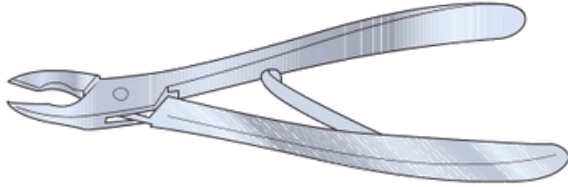

Code	Description
SC-G1/459	180mm long

## Kleinert Kutz Bone Rongeur

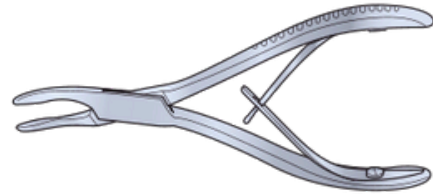

Code	Description
SC-OR/009a	Curved, 140mm, width 2mm
SC-OR/009	Curved, 155mm, width 2mm
SC-OR/011	Curved, 155mm, width 3mm

## Horsley Compound Action Bone Cutter

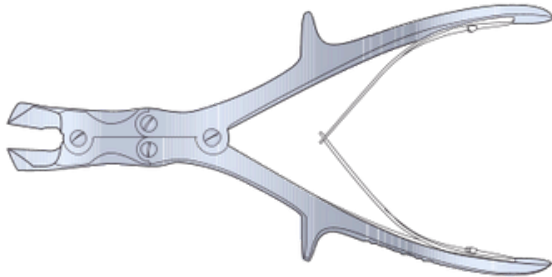

Code	Description
SC-OR/002	235mm long

## Kleinert Kutz Skin Hooks



Code	Description
SC-PL/109	16cm large
SC-PL/108	16cm medium
SC-PL/107	16cm small

## Stamms Box Joint Bone Cutter

Standard, stainless steel

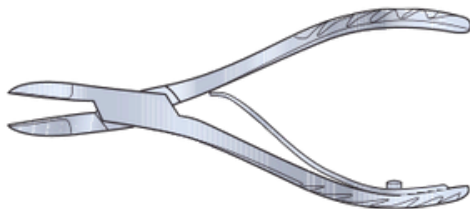

Code	Description
SC-OR/N056	140mm long

# Bone Rongeurs

## Echlin Compound Action Bone Rongeur

Straight, with or without horn, 230mm long

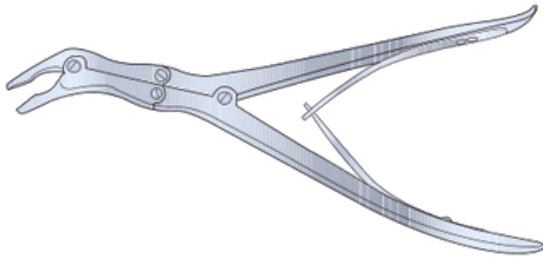

Code	Description
SC-OR/005	Width 2mm
SC-OR/006	Width 3mm
SC-OR/007	Width 4mm

## Stille Compound Action Bone Rongeur

Angled to side, 240mm long



Code	Description
SC-OR/037	11mm bite

## Leksell Compound Action Bone Rongeur

250mm long

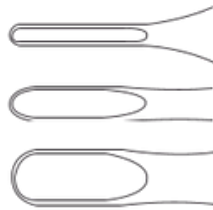
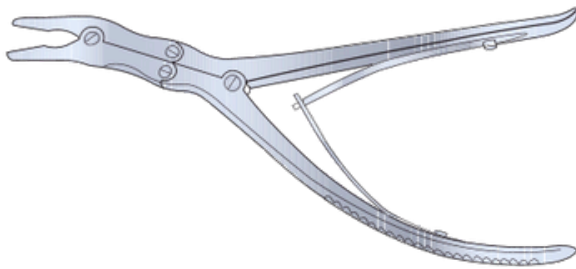

Code	Description
SC-OR/066	3mm bite
SC-OR/069	5mm bite
SC-OR/065	8mm bite

## Leksell Stille Compound Action Bone Rongeur

240mm long

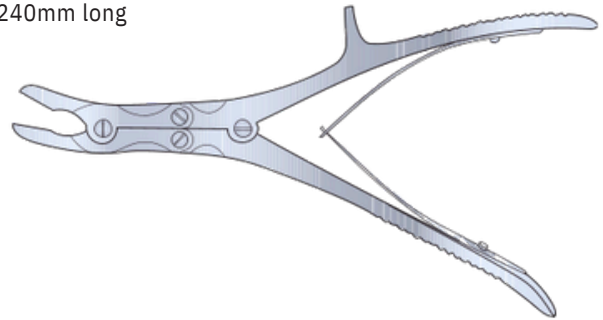

Code	Description
SC-OR/065a	8mm bite

## Leksell Compound Action Bone Rongeur

240mm long

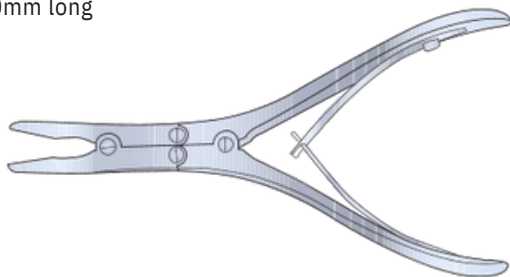

Code	Description
SC-OR/008	Width 3mm

## Luer Stille Compound Action Bone Rongeur

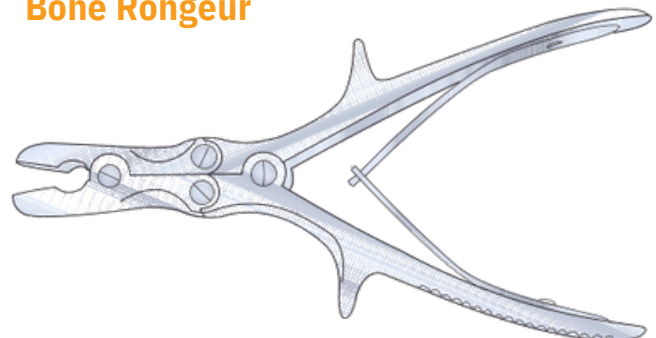

Straight

Curved

Code	Description
SC-OR/071	10mm bite, 220mm long
SC-OR/072	12mm bite, 260mm long

Code	Description
SC-OR/071a	10mm bite, 220mm long
SC-OR/071b	11mm bite, 230mm long

## Luer Compound Action Bone Rongeur

6mm bite, 190mm long

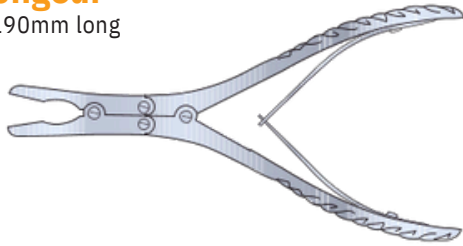

Code	Description
SC-OR/13	Straight
SC-OR/13a	Curved



## Ruskin Compound Action Bone Rongeur

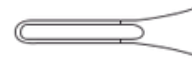
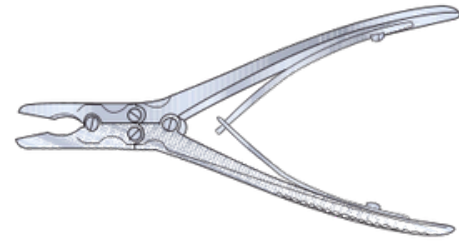

3mm bite, 150mm long

Code	Description
SC-OR/034	Straight
SC-OR/035	Curved

4mm bite, 185mm long

Code	Description
SC-OR/028	Straight
SC-OR/036	Curved

## Luer Box Joint Bone Rongeur

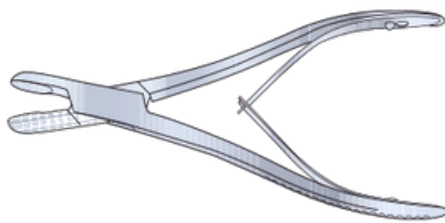

Straight, 185mm long

Code	Description
SC-OR/031	8mm bite
SC-OR/041	10mm bite

Curved, 210mm long

Code	Description
SC-OR/042	8mm bite

## Compound Action Bone Rongeur

Lightweight pattern, curved, 150mm long

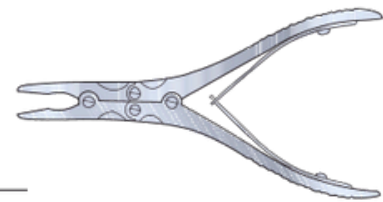

Code	Description
SC-OR/013d	4mm bite

## Cushing Screw Joint Bone Rongeur

190mm long

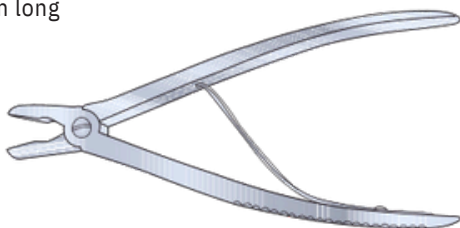

Straight

Code	Description
SC-OR/039	4mm bite
SC-OR/058	6mm bite
SC-OR/059	8mm bite

Curved

Code	Description
SC-OR/060	4mm bite
SC-OR/067	6mm bite
SC-OR/068	8mm bite

## Lempert Box Joint Bone Rongeur

3mm bite, 155mm long

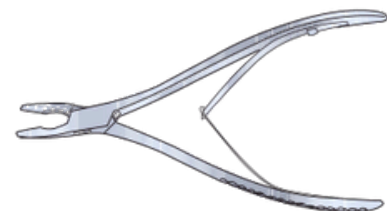

Code	Description
SC-OR/327	Straight
SC-OR/010	Curved

# Bone Holding Forceps

## Lambotte Bone Holding Forceps

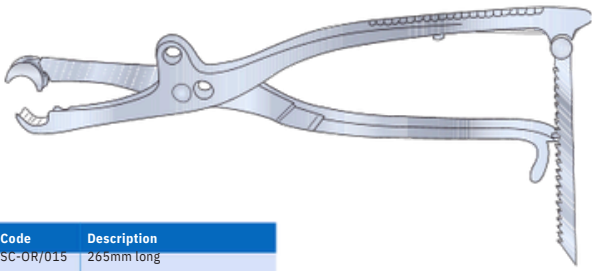

Code	Description
SC-OR/015	265mm long

## Bone Holding Forceps

Screw joint, with holding screw

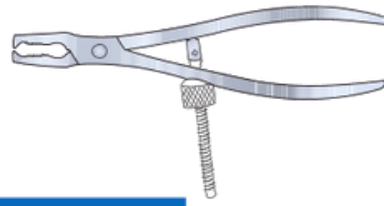

Code	Description
SC-OR/029	165mm long

## Lambotte Bone Holding Forceps

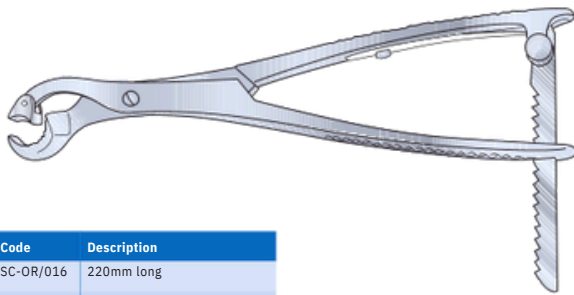

Code	Description
SC-OR/016	220mm long
SC-OR/017	215mm long
SC-OR/022	330mm long

## Hey Groves Bone Holding Forceps

With screw locking device



Code	Description
SC-OR/29d	200mm long
SC-OR/29e	225mm long
SC-OR/29f	305mm long

## Farabeuf Bone Holding Forceps

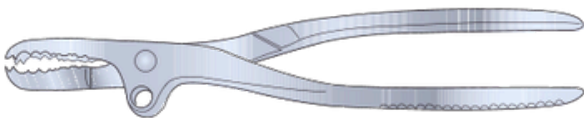

Code	Description
SC-OR/021	230mm long
SC-OR/328	250mm long

## Bone Holding Forceps

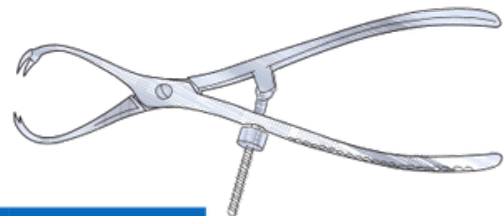

Code	Description
SC-OR/13	140mm long
SC-	185mm long
OR/014	215mm long
SC-	275mm long
OR/018	
SC-	
OR/019	

## Farabeuf-Lambotte Bone Holding Forceps

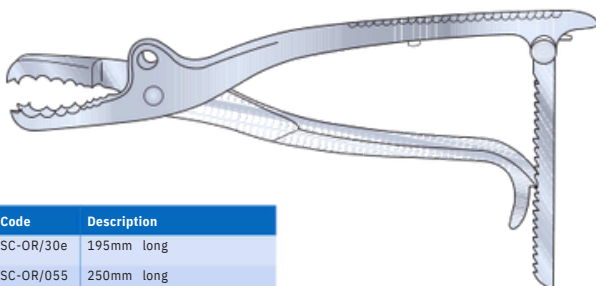

Code	Description
SC-OR/30e	195mm long
SC-OR/055	250mm long
SC-OR/30f	260mm long

## Fergusson Bone Holding Forceps



Code	Description
SC-OR/30	150mm long
SC-OR/30a	200mm long
SC-OR/30b	230mm long

## Frosch Bone Holding Forceps

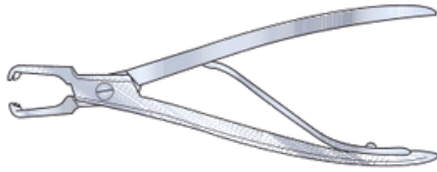

Code	Description
SC-OR/NO61	180mm long

## Sequestrum (Necrosis) Forcep

Straight, long fine jaws

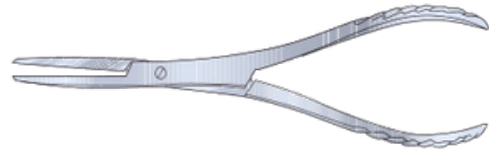

Code	Description
SC-OR/SEQ001	191mm long
SC-OR/SEQ002	203mm long

## Joint Calcaneal Spreader

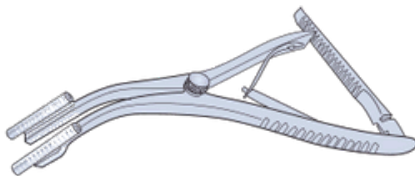

Code	Description
SC-OR/CAL001	40mm opening, 1.6mm ø, 170mm long

## Calcaneal Spreader

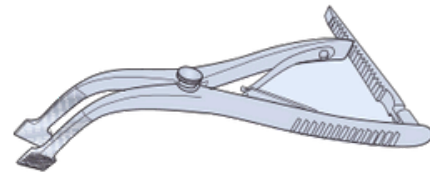

Code	Description
SC-OR/CAL002	40mm opening, 15mm wide tip, 70mm long

## Inge Type Lamina Spreader

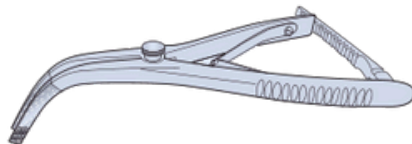

Code	Description
SC-OR/CAL003	40mm opening, no teeth, 5mm wide tip, 170mm long

## Inge Type Lamina Spreader

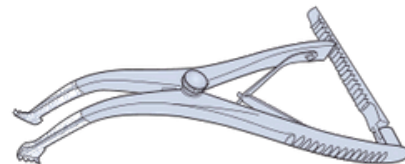

Code	Description
SC-OR/CAL004	Baby, 40mm opening, with teeth, 10mm wide tip, 160mm long
SC-OR/CAL004a	50mm opening, with teeth, 10mm wide tip, 240mm long

## Harrison Bone Holding Forceps



Code	Description
SC-OR/30d	190mm long

## St Thomas Bone Holding Forceps



Code	Description
SC-OR/403c	182mm long

# Bone Holding Forceps and Clamps

## Burns Bone Holding Forceps

Box joint

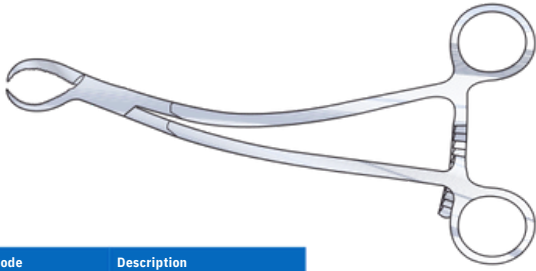

Code	Description
SC-OR/29a	200mm long

## Scarf Type Clamp

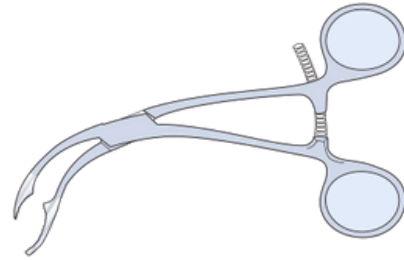

Code	Description
SC-OR/SCA	150mm long

## Orthopaedic Grasping Forceps

Box joint

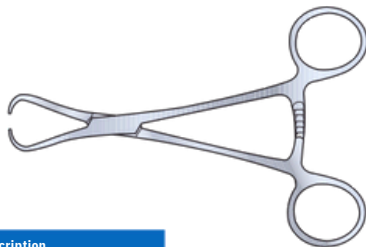

Code	Description
SC-OR/29b	125mm
SC-OR/29c	long
	165mm
	long

## Lowman Bone Holding Clamp

Infant 125mm long  
Child 175mm long  
Adult 205mm long

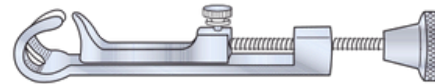

Code
SC-OR/28

## Reduction Forcep

With adjustable lock



Code	Description
SC-OR/RED001a	Small, 135mm long
SC-OR/RED001b	Large, 168mm long

## Parker Modified Lowman Bone Holding Clamp, Single

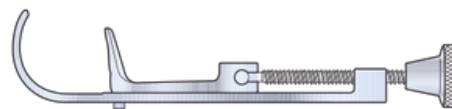

Code	Description
SC-OR/5644	160mm long

## Verbrugge Bone Holding Forceps



Code	Description
SC-OR/30c	180mm long

## Parker Retractor

For use with Lowman clamp

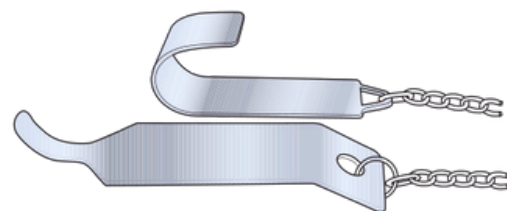

Code	Description
SC-OR/5643	Chain 850mm long



## Haglund Plaster Spreader

Working part curved in right



Code	Description
SC-OR/207	280mm long

## Plaster Cutter

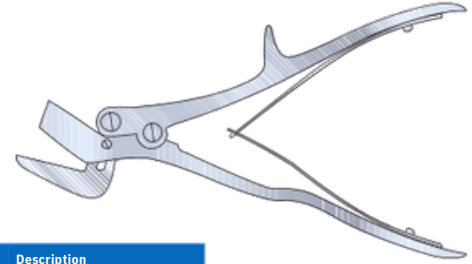

Code	Description
SC-OR/40	240mm long

## Lawton Plaster Spreader

Working part curved in right

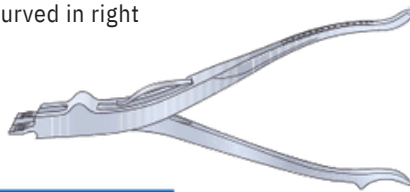

Code	Description
SC-OR/208	220mm long

## Bohler Plaster Shears

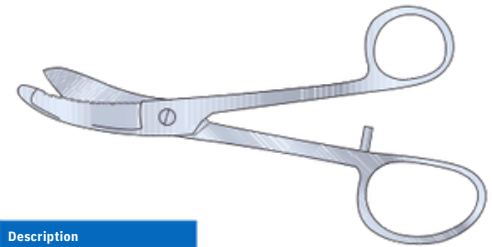

Code	Description
SC-OR/38	240mm long

## Henning Plaster Spreader



Code	Description
SC-OR/211	270mm long

## Guys Plaster Shears



Code	Description
SC-OR/39	240mm long

## Wolf Plaster Spreader



Code	Description
SC-OR/212	180mm long
SC-OR/329	250mm long

## Engel Plaster Saw



Code	Description
SC-OR/40b	150mm long

## Stille Type Plaster Shears



Code	Description
SC-OR/210	380mm long
SC-OR/210a	330mm long
SC-OR/210b	460mm long

## Eccentric Plaster Shears

Without heavy serrated blade

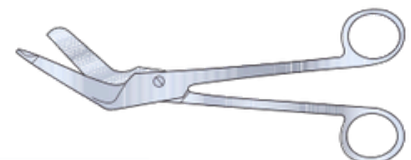

Code	Description
SC-OR/40a	190mm long

# Bone Curettes

## Bone Curette

Straight, 180mm long

Code	Description	Code	Description
SC-OR/075	Width 2mm	SC-OR/079	Width 10mm
S C- O R	Width 4mm	SC-OR/080	Width 12mm
/076 SC-	Width 6mm	SC-OR/081	Width 14mm
OR/077	Width 8mm	SC-OR/082	Width 16mm
SC-OR/078			

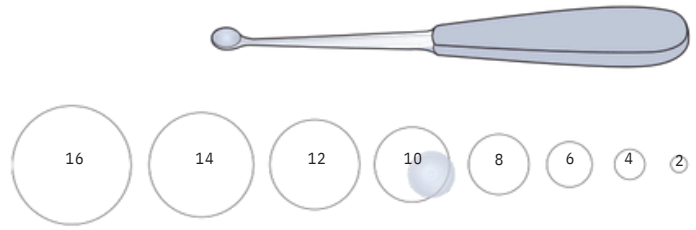

## Bone Curette

Straight, 260mm long

Code	Description	Code	Description
SC-OR/083	Width 2mm	SC-OR/086	Width 8mm
SC-OR/084	Width 4mm	SC-OR/087	Width 10mm
SC-OR/085	Width 6mm	SC-OR/088	Width 12mm

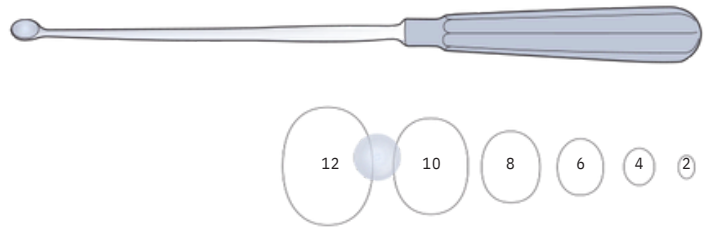

## Bone Curette

Straight, 210mm long

Code	Description
SC-OR/089	Width 2mm
SC-OR/090	Width 4mm
SC-OR/091	Width 6mm
SC-OR/092	Width 8mm
SC-OR/093	Width 10mm
SC-OR/094	Width 12mm
SC-OR/095	Width 14mm
SC-OR/096	Width 16mm
SC-OR/097	Width 20mm

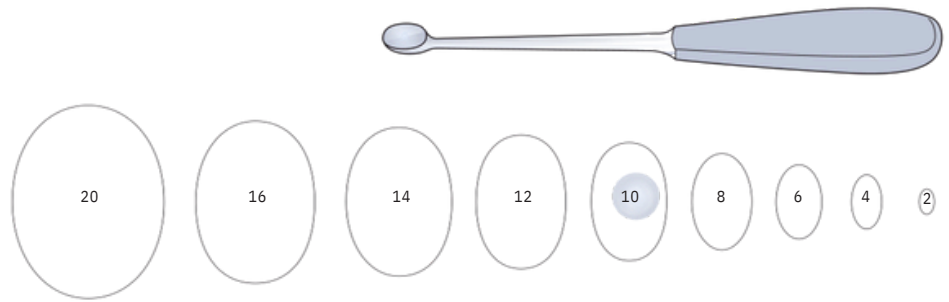

## Busche Bone Curette

Angled, 250mm long

Code	Description
SC-OR/138	Width 3mm
SC-OR/139	Width 4mm
SC-OR/140	Width 5mm

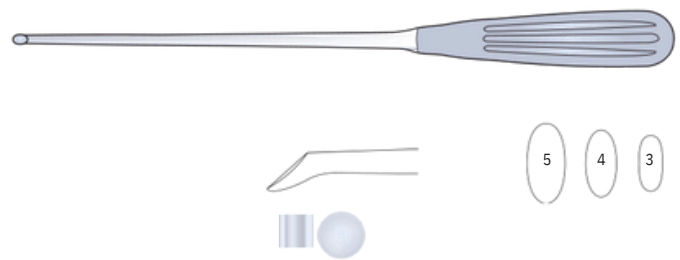

## Bruns Bone Curette

225mm long

Straight

Angled

Code	Description	Code	Description
SC-OR/189	Width 3mm	SC-OR/195	Width 3mm
SC-OR/190	Width 4mm	SC-OR/196	Width 4mm
SC-OR/191	Width 5mm	SC-OR/197	Width 5mm
SC-OR/192	Width 6mm	SC-OR/198	Width 6mm
SC-OR/193	Width 7mm	SC-OR/199	Width 7mm
SC-OR/194	Width 8mm	SC-OR/200	Width 8mm

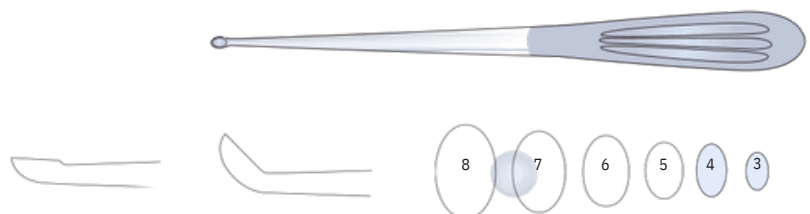

## Gourdet Bone Curette

Straight, blunt  
 280mm long

Code	Description
SC-OR/157	Width 6mm
SC-OR/158	Width 8mm
SC-OR/159	Width 10mm
SC-OR/160	Width 12mm
SC-OR/161	Width 14mm

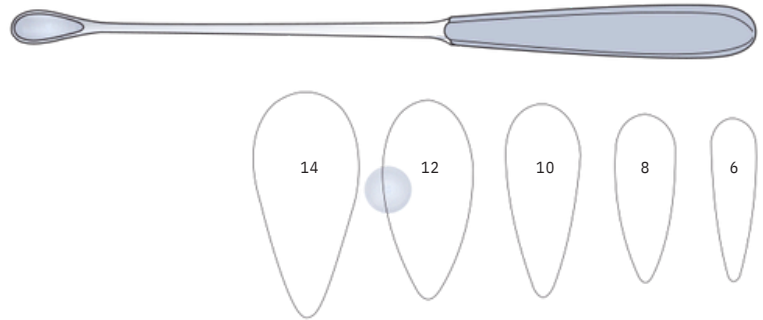

## Shroeder Bone Curette

Straight, 310mm long

Code	Description
SC-OR/151	Width 6mm
SC-OR/152	Width 8mm
SC-OR/153	Width 10mm
SC-OR/154	Width 12mm
SC-OR/155	Width 14mm

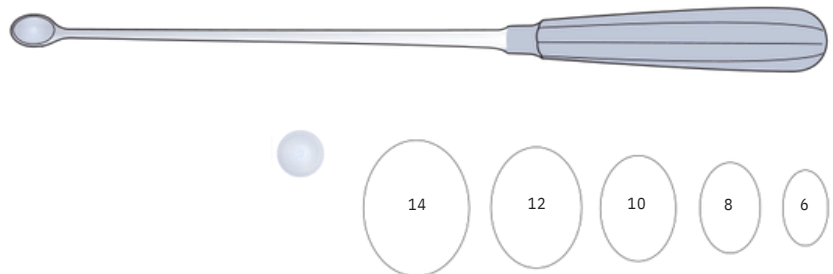

## Simon Bone Curette

Straight, 240mm long

Code	Description
SC-	Width 6mm
OR/145	Width 8mm
SC-	Width 10mm
OR/146	Width 12mm
SC-	Width 14mm

OR/147

SC-

OR/148

SC-

## Spinal Curette

Overall 205mm long

Code	Description	Code	Description
SC-OR/031a	Width 4mm	SC-OR/031e	Width 8mm
SC-OR/031b	Width 5mm	SC-OR/031f	Width 9mm
SC-OR/031c	Width 6mm	SC-OR/031g	Width 10mm
SC-OR/031d	Width 7mm	SC-OR/031h	Width 11mm

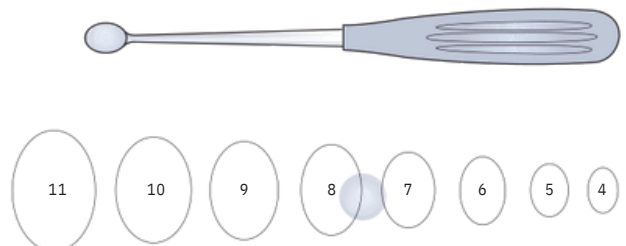
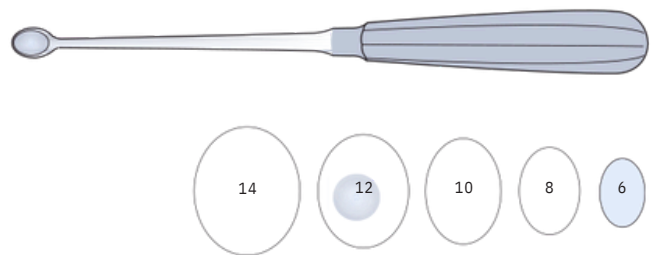

# Bone Curettes

## Volkman Bone Curette

Straight, 170mm long

Code	Description
SC-	Width 2mm
OR/112	Width 3mm
SC-	Width 4mm
OR/113	Width 5mm
SC-	Width 6mm

Code	Description
SC-	Width 8mm
OR/117	Width 10mm
SC-	Width 12mm
OR/118	Width 14mm

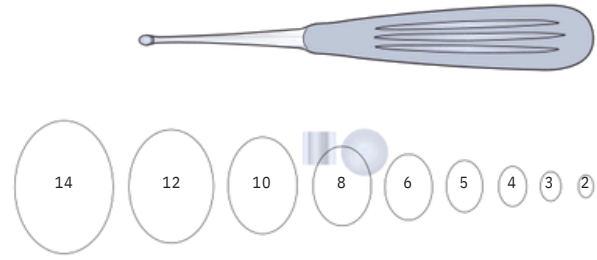

## Volkman Bone Curette

Straight, 230mm long

Code	Description
SC-OR/SH.5687	Bowl width 10mm, bowl length 14.5mm



## Wallich Bone Curette

Blunt

Code	Description
SC-OR/162	420mm long

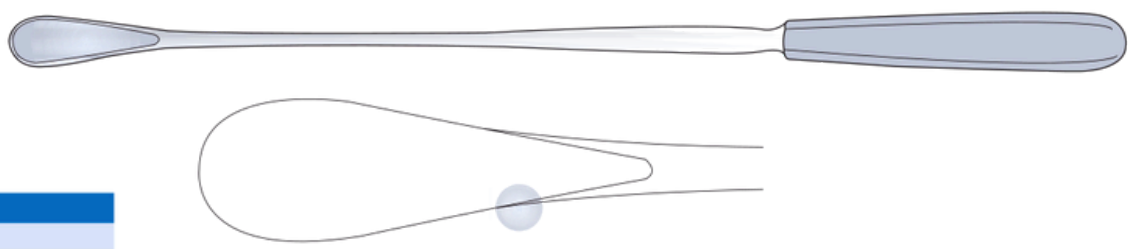

## Williger Bone Curette

Straight, 170mm long

Code	Description
SC-	Width 3.5mm
OR/122	Width 5.5mm



## Charnley Bone Curette

With T handle,  
380mm long

Code	Description
SC-OR/N040	Large, 20 x 14mm
SC-OR/N041	Medium, 17 x 12mm
SC-OR/N042	Small, 11 x 8mm



## Sypert Bone Curette

Blue acetal "Suregrip" handle, 380mm long



### Straight

Code	Description
SC-OR/236	Width 3mm
SC-OR/237	Width 4mm
SC-OR/238	Width 5mm

### Angled

Code	Description
SC-OR/240	Width 3mm
SC-OR/241	Width 4mm
SC-OR/245	Width 5mm



## Bone Curette

Blue acetal "Suregrip" handle, 410mm long



### Straight

Code	Description
SC-OR/249	Width 3mm
SC-OR/250	Width 4mm
SC-OR/251	Width 5mm

### Angled

Code	Description
SC-OR/252	Width 3mm
SC-OR/253	Width 4mm
SC-OR/254	Width 5mm



## Caspar Bone Curette

Blue acetal "Suregrip" handle, 220mm long



### Straight

Code	Description
SC-OR/230	Width 3.5mm
SC-OR/231	Width 4.5mm
SC-OR/232	width 5.5mm

### Angled

Code	Description
SC-OR/233	Width 3.5mm
SC-OR/234	Width 4.5mm
SC-OR/235	Width 5.5mm



## Bone Curette

Blue acetal "Suregrip" handle, 270mm long, straight



Code	Description
SC-OR/226	Width 4mm
SC-OR/227	Width 6mm
SC-OR/228	Width 8mm
SC-OR/229	Width 10mm

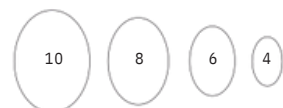

## Bone Curettes

### Capener Spoon

Blue acetal "Suregrip" handle 285mm long

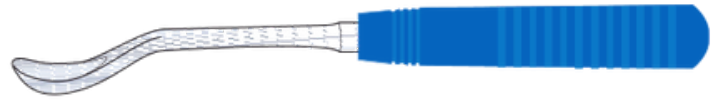

Code	Description
SC-OR/389a	Width 16mm
SC-OR/389b	Width 20mm

### Capener Lamina Curette

Blue acetal "Suregrip" handle 300mm long



Code	Description
SC-OR/389c	12 x 32mm
SC-OR/389d	6 x 18mm

### Stanley Boyd Curette

Double ended



Code	Description
SC-	Small - 50mm long
OR/162a	Medium - 200mm long
SC-	Large - 250mm long
OR/162b	
SC-OR/162c	

### Volkman Bone Scoop

Double-ended, straight



Code	Description
SC-OR/31	175mm long
SC-	220mm long
OR/213	220mm long
SC-	
OR/175	

### Martini Bone Curette

Shown at half size  
double-ended, straight 140mm long



Code	Description
SC-OR/170	Small and medium
SC-OR/171	Medium and large

## Lane Bone Lever

240mm long

### 6mm

Code	Description
SC-OR/N011	Slight curve
SC-OR/N012	Full curve

### 8mm

Code	Description
SC-OR/N013	Slight curve
SC-OR/N014	Full curve



## Lane Bone Lever

For small bones



Code	Description
SC-OR/N015	10mm wide, 265mm long

## Lane Bone Lever

For small bones, serrated end



Code	Description
SC-OR/N016	10mm wide, 260mm long

## Trethowan Bone Lever

Ring handle



Code	Description
SC-OR/N017	220mm long

## Watson-Jones Bone Lever



Code	Description
SC-OR/N054	275mm long

## Bankhart Bone Lever



Code	Description
SC-OR/SH.5315	300mm long

# Retractors

## Hip Set



### Femoral Dislocation Lever 285mm

Code	Description
SC-OR/N059A	Spoon elevator 25mm with blue acetal suregrip handle – large



### Muller Curette 240mm

Code	Description
SC-OR/N059B	Curette 27mm with blue acetal suregrip handle – large



### Muller Curette 270mm

Code	Description
SC-OR/N059C	Curette 9mm with blue acetal suregrip handle – small



### Curved Osteotome 260mm

Code	Description
SC-OR/N059D	With blue acetal suregrip handle - 2



### Small Gouge 240mm

Code	Description
SC-OR/N059E	8mm cranked blue acetal suregrip handle



## Charnley Initial Incision Retractor

Code	Description
SC-OR/N038a	Frame only
SC-OR/N038b	Weight only, 75mm x 50mm ø
SC-OR/N038s	Goal post pins and chain

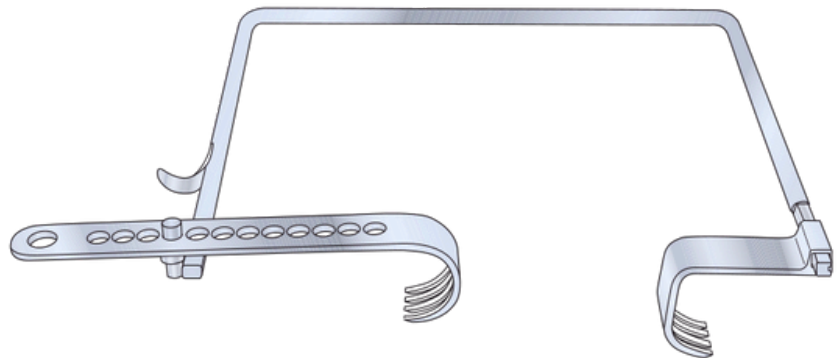

### Short blades

Code	Description
SC-OR/N038r	Short blade, 25mm deep
SH006084	Short blade, 35mm deep
SC-OR/N038c	Short blade, 50mm deep
SC-OR/N038l	Short blade, 65mm
SC-OR/N038e	Short blade, 75mm deep
SC-OR/N038q	Short blade, 80mm deep
SC-OR/N038g	Short blade, 100mm deep
SH003879	Short blade, 125mm
SH003880	Short blade, 150mm

### Long blades

Code	Description
SH006085	Long blade, 35mm deep
SC-OR/N038d	Long blade, 50mm deep
SC-OR/N038k	Long blade, 65mm
SC-OR/N038p	Long blade, 70mm deep
SC-OR/N038f	Long blade, 75mm deep
SC-OR/N038h	Long blade, 100mm deep
SH003877	Long blade, 125mm
SH003878	Long blade, 150mm
SC-OR/N038m	Long round blade, 50mm deep

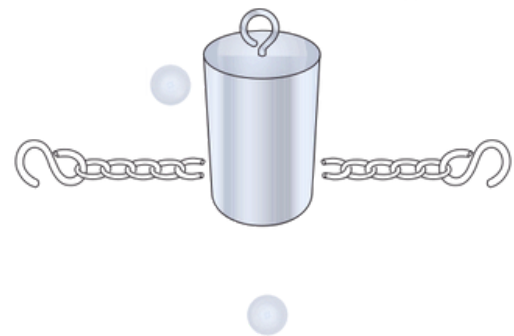



## Travers Retractor

Self retaining, internal rack, 210mm long

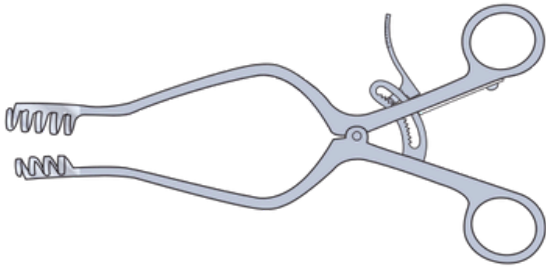

Code	Description
SC-G1/323	4 x 5 teeth, 95mm fully open

## Jackson Burrows Retractor

Self retaining

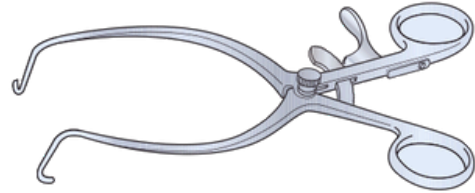

Code	Description
SC-G1/377	175mm

## West Retractor

Self retaining, 140mm long

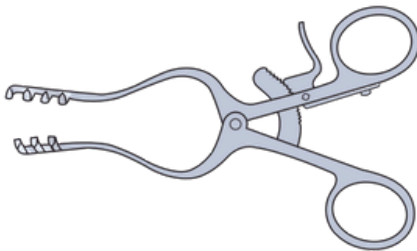

Code	Description
SC-G1/326	3 x 4 teeth, 60mm fully open
SC-G1/326cr	3 x 4 teeth, 60mm fully open, with cam rack

## Norfolk and Norwich Retractor

4 x 5 teeth 50mm blades x 223mm long

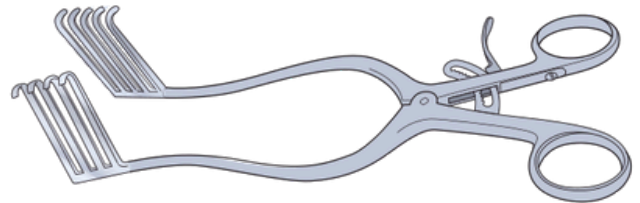

Code	Description
SC-G1/325	Standard rack

## Jackson Burrows Hand Retractor

225mm long

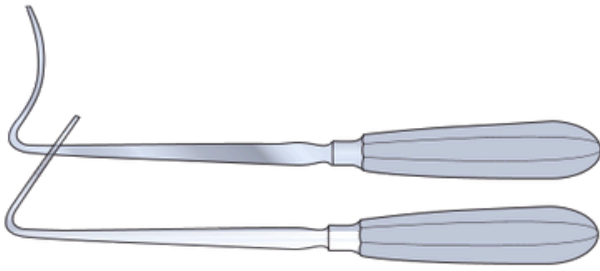

Code	Description
SC-OR/N050	Narrow curve, 13mm blade
SC-OR/N050a	Broad, angular, 20mm blade

## Kocher Bone Hook

220mm long



Code	Description
SC-OR/N036	Sharp
SC-OR/N036a	Blunt

## Ballance (Volkman) Retractor

203mm long



### Sharp

Code	Description
SC-GI/463	1 prong
SC-GI/463a	2 prong
SC-GI/463b	3 prong
SC-GI/463c	4 prong
SC-GI/463d	6 prong

### Blunt

Code	Description
SC-GI/463e	1 prong
SC-GI/463f	2 prong
SC-GI/463g	3 prong
SC-GI/463h	4 prong
SC-GI/463i	6 prong

## Langenbeck Bone Hook



Code	Description
SC-OR/391	200mm long

## Jackson Burrows Dissecting Forcep

140mm long



Code	Description
SC-OR/N037	Tongue and groove only
SC-OR/N037a	Tongue and groove, 1-2 teeth

## Dislocation Hook

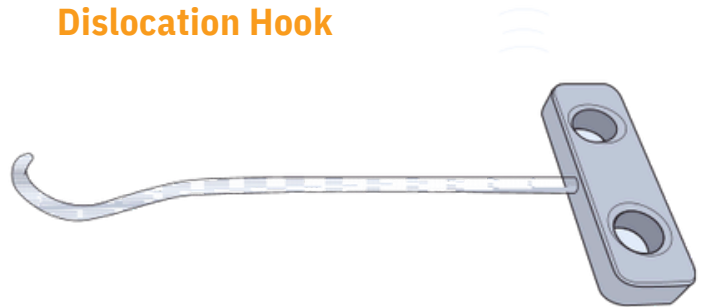

Code	Description
SC-OR/SH-5703	253mm long

## Charnley-McIndoe Dissecting Forceps

150mm long



Code	Description
SC-OR/N045a	2-3 teeth

## Dislocation Hip Hook

Blue acetal "Suregrip" handle

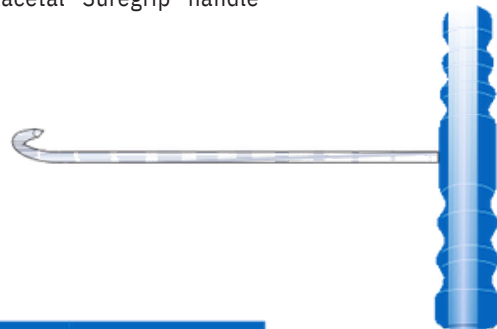

Code	Description
SC-OR/420	185mm long

## Key Raspatories



Code	Description
SC-	Width 6.4mm 180mm long
OR/310	Width 9.5mm 190mm long
SC-	Width 12.7mm 190mm long
OR/313	Width 19mm 200mm long
SC-	Width 25.4mm 210mm long

OR/311

SC-

OR/312

## SC Lambotte Raspatory

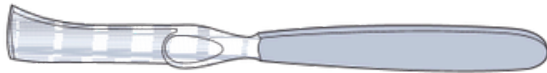
 OR/314  
 205mm Long

Code	Description
SC-OR/242	Width 10mm
SC-OR/243	Width 15mm
SC-OR/244	Width 20mm

## Paton Bone Burr

Satin handle, 155mm long

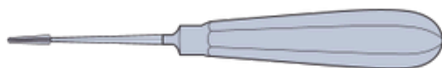

Code	Description
SC-OR/403	3.5mm ø x
SC-OR/403a	17mm 4.5mm ø
SC-OR/403b	x 17mm 5.0mm ø x 17mm

## Robert Jones Rugine

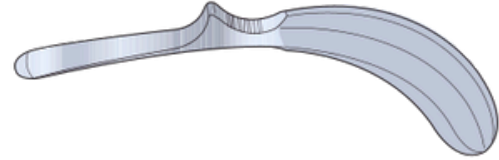
 Convex sharp edge, fan shaped end,  
 with solid pistol handle

Code	Description
SC-OR/N035	185mm long

## Mitchell Rugine

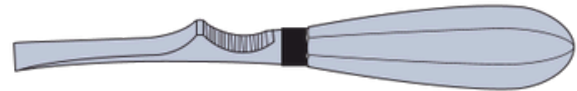
 Straight, sharp edge,  
 fan shaped, hollow handle

Code	Description
SC-OR/N034	210mm long

## Farabeuf Rugine

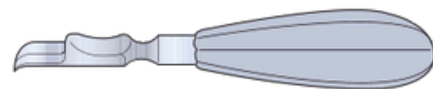
 Curved end, chisel edge,  
 hollow handle

Code	Description
SC-OR/N033	160mm long

# Osteotomes, Chisels and Gouges

## Lexer Osteotome

Blue acetal "Suregrip" handle, 180mm long



Code	Description
SC-OR/SH5347a	4mm

## Capener Lamina Gouge

Blue acetal "Suregrip" handle, straight, 265mm long



Code	Description
SC-OR/362	Width 6mm
SC-OR/363	Width 10mm
SC-OR/364	Width 12mm

Code	Description
SC-OR/365	Width 15mm
SC-OR/366	Width 20mm
SC-OR/367	Width 25mm

## Capener Osteotome

Blue acetal "Suregrip" handle, 250mm long



### Shallow curved

Code	Description
SC-OR/384	Width 6mm
SC-OR/385	Width 10mm
SC-OR/386	Width 12mm
SC-OR/387	Width 15mm
SC-OR/388	Width 20mm
SC-OR/389	Width 25mm
SC-OR/390	Width 30mm

### Acute curved

Code	Description
SC-OR/390a	Width 6mm
SC-OR/390b	Width 10mm
SC-OR/390c	Width 15mm
SC-OR/390d	Width 20mm
SC-OR/390e	Width 25mm

## Capener Lamina Gouge

Cranked, blue acetal "Suregrip" handle, 250mm long



Code	Description
SC-OR/373c	Width 6mm
SC-OR/373d	Width 8mm
SC-OR/373j	Width 10mm
SC-OR/373e	Width 11mm
SC-OR/373f	Width 16mm
SC-OR/373k	Width 17mm

### With reversed edge

Code	Description
SC-OR/373cre	Width 6mm
SC-OR/373dre	Width 8mm
SC-OR/373jre	Width 10mm
SC-OR/373ere	Width 11mm
SC-OR/373fre	Width 16mm
SC-OR/373kre	Width 17mm

OTHER LENGTHS AND SIZES AVAILABLE

## Capener Osteotome

Blue acetal "Suregrip" handle, straight, 255mm long



Code	Description
SC-OR/374	Width 6mm
SC-OR/375	Width 8mm
SC-OR/376	Width 10mm
SC-OR/377	Width 12mm
SC-OR/378	Width 13mm

Code	Description
SC-OR/379	Width 15mm
SC-OR/380	Width 18mm
SC-OR/381	Width 20mm
SC-OR/382	Width 25mm
SC-OR/383	Width 30mm

## Capener Lamina Gouge

Swan neck, blue acetal "Suregrip" handle, 250mm long



Code	Description
SC-OR/373g	Width 8mm

## Capener Chisel

Blue acetal "Suregrip" handle straight, 250mm long



Code	Description
SC-OR/368	Width 6mm
SC-OR/369	Width 10mm
SC-OR/370	Width 12mm

Code	Description
SC-OR/371	Width 15mm
SC-OR/372	Width 20mm
SC-OR/373	Width 25mm

## Capener Lamina Gouge

Reverse cranked, blue acetal "Suregrip" handle, 245mm long



Code	Description
SC-OR/373ar	Width 11mm
SC-OR/373nr	Width 16mm
SC-OR/373jr	Width 17mm

Code	Description
SC-OR/3730r	Width 6mm
SC-OR/3731r	Width 8mm
SC-OR/3733r	Width 10mm

## Swedish Pattern Chisel

200mm long

### Read Osteotome

 Serrated head  
 180mm long

Code	Description
SC-OR/335	Width 4mm
SC-OR/336	Width 5mm

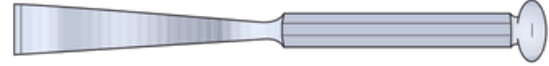

### With tungsten carbide edge

Code	Description
SC-OR/353	Width 10mm
SC-OR/354	Width 15mm
SC-OR/355	Width 20mm
SC-OR/356	Width 25mm
SC-OR/357	Width 30mm

Code	Description
SC-OR/355tc	Width 20mm
SC-OR/356tc	Width 25mm
SC-OR/357tc	Width 30mm
SC-OR/356tc	Width 25mm
SC-OR/357tc	Width 30mm

### Read Gouge

Serrated head, 180mm long



Code	Description
SC-OR/344	Width 2mm
SC-OR/345	Width 3mm
SC-OR/346	Width 4mm
SC-OR/347	Width 5mm

Code	Description
SC-OR/341	Width 6mm
SC-OR/342	Width 7mm
SC-OR/343	Width 8mm

## Swedish Pattern Gouge

200mm long

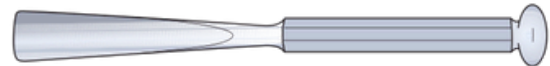

### With tungsten carbide edge

Code	Description
SC-OR/358	Width 10mm
SC-OR/359	Width 15mm
SC-OR/360	Width 20mm
SC-OR/361	Width 25mm

Code	Description
SC-OR/358tc	Width 10mm
SC-OR/359tc	Width 15mm
SC-OR/360tc	Width 20mm
SC-OR/361tc	Width 25mm

### Read Chisel

Serrated head, 180mm long



Code	Description
SC-OR/337	Width 2mm
SC-OR/338	Width 3mm
SC-OR/339	Width 4mm
SC-OR/340	Width 5mm

Code	Description
SC-OR/341	Width 6mm
SC-OR/342	Width 7mm
SC-OR/343	Width 8mm

## Lambotte Osteotome

230mm long



## Swedish Pattern Osteotome

200mm long



Code	Description
SC-OR/348	Width 10mm
SC-OR/349	Width 15mm
SC-OR/350	Width 20mm
SC-OR/351	Width 25mm
SC-OR/352	Width 30mm

### With tungsten carbide edge

Code	Description
SC-OR/348tc	Width 10mm
SC-OR/349tc	Width 15mm
SC-OR/350tc	Width 20mm
SC-OR/351tc	Width 25mm
SC-OR/352tc	Width 30mm

### Straight

Code	Description
SC-OR/392	2mm wide
SC-OR/392a	4mm wide
SC-OR/392b	7mm wide
SC-OR/392c	15mm wide
SC-OR/392d	20mm wide
SC-OR/392e	25mm wide
SC-OR/392f	30mm wide
SC-OR/392g	38mm wide
SC-OR/392h	44mm wide
SC-OR/392i	50mm wide

### Curved

Code	Description
SC-OR/392j	15mm wide
SC-OR/392k	20mm wide
SC-OR/392m	25mm wide
SC-OR/392n	30mm wide
SC-OR/392o	38mm wide
SC-OR/392p	40mm wide
SC-OR/392q	44mm wide
SC-OR/392r	50mm wide

# Osteotomes, Chisels and Gouges

## Albee Osteotome

190mm long

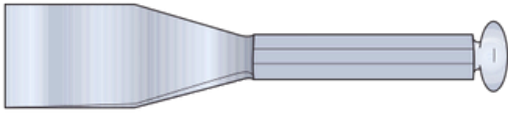

Code	Description
SC-OR/NO62a	Width 38mm
SC-OR/NO62b	Width 50mm

## Small Gouges

150mm long



Code	Description
SC-OR/16-	4mm wide
4 SC-	6mm wide
OR/16-6	8mm wide

8

## Moore Hollow Osteotome

Rectangular, for curved standard stems



Code	Description
SC-OR/N008	135mm long
SC-OR/N008a	255mm long

## Box Chisel

Blue acetal "Suregrip" handle, 285mm long



Code
SC-OR/N008b

## Small Osteotomes

150mm long



Code	Description
SC-OR/14-	4mm wide
4 SC-	6mm wide
OR/14-6	8mm wide

SC-OR/14-

8

## Alexander Gouge

Straight, 170mm long



Code	Description
SC-OR/290	Width 5mm
SC-OR/291	Width 7mm

Code	Description
SC-OR/292	Width 9mm
SC-OR/293	Width 11mm

## Small Chisels

150mm long



Code	Description
SC-OR/18-	4mm wide
4 SC-	6mm wide
OR/18-4	8mm wide

SC-OR/18-

4

## Partsch Gouge

Straight



140mm long

Code	Description
SC-OR/283	Width 3mm
SC-OR/284	Width 4mm
SC-OR/285	Width 5mm
SC-OR/286	Width 6mm

170mm long

Code	Description
SC-OR/294	Width 3mm
SC-OR/287	Width 4mm
SC-OR/295	Width 5mm
SC-OR/288	Width 6mm
SC-OR/289	Width 7mm

## Wire Cutting Pliers

Tungsten carbide edge, for cutting up to and including 6mm  $\varnothing$

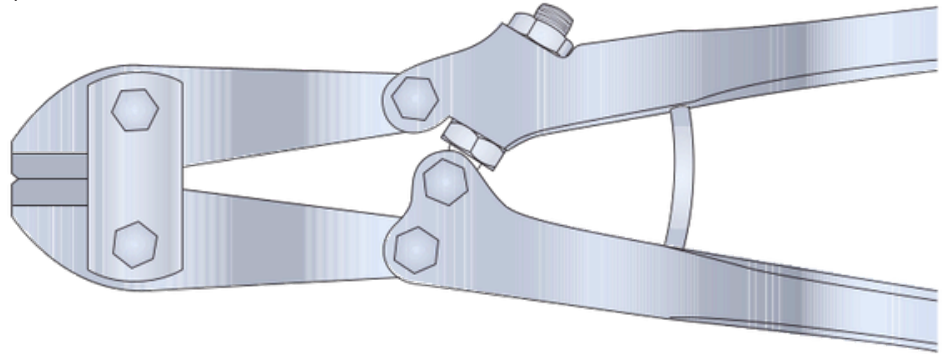

Code	Description
SC-OR/258	450mm long
SC-OR/259	560mm long

## Wire Cutting Pliers

Tungsten carbide edge, for cutting Kirschner wires up to and including 5.5mm  $\varnothing$

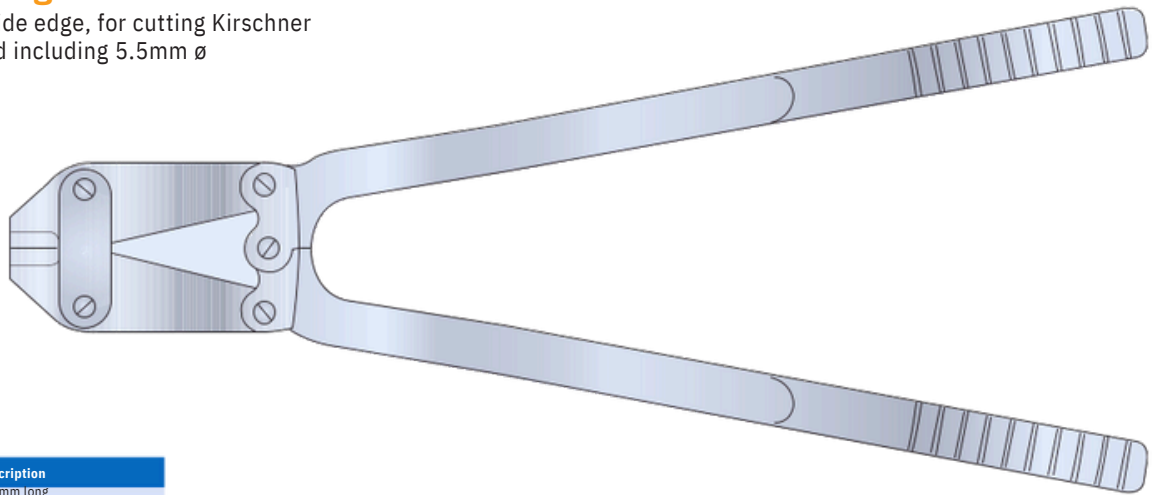

Code	Description
SC-OR/07a	480mm long

## Wire Cutting Pliers

Tungsten carbide edge, for cutting Kirschner wires up to 4mm  $\varnothing$

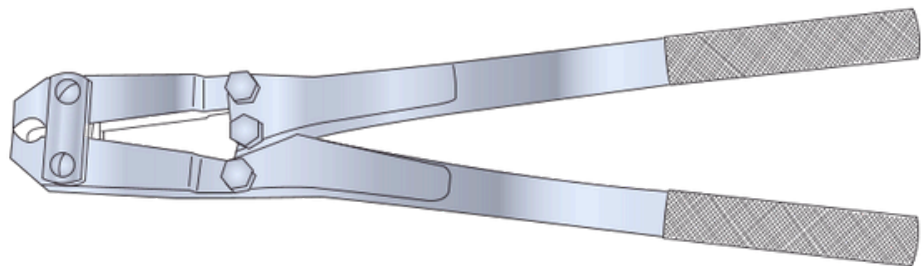

Code	Description
SC-OR/261	380mm long

# Wire Cutters and Pliers

## Top Cutter

Gold handles, tungsten carbide edge, for cutting Kirschner wire

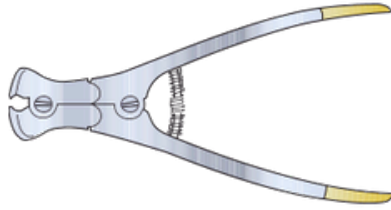

Code	Description
SC-OR/06	Up to 2.5mm, 215mm long
SC-OR/06a	Up to 1.5mm, 145mm long

## Side Cutter

Gold handles, tungsten carbide edge, jaws have rounded edges, for cutting Kirschner wires

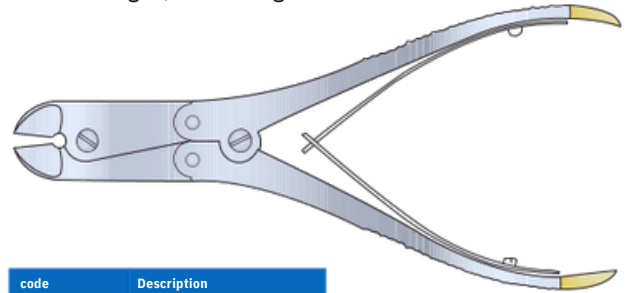

code	Description
SC-OR/331	Up to 2.5mm ø, 230mm long
SC-OR/332	Up to 2.2mm ø, 215mm long
SC-OR/333	Up to 1.5mm ø, 145mm long

## Top and Side Cutter

Small, gold handles, tungsten carbide edge, for cutting Kirschner wires up to 1.5mm ø

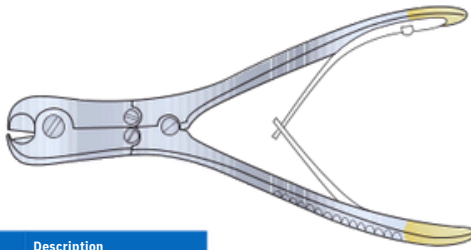

Code	Description
SC-OR/06b	175mm long

## Wire Cutting Pliers

Gold handles, tungsten carbide edge, 120mm long

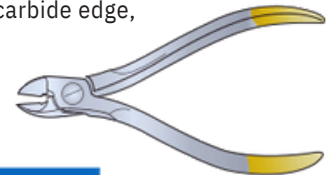

Code	Description
SC-OR/263	For wire up to 0.2mm ø For wire up
SC-OR/267	to 0.3mm ø For wire up to 0.5mm ø
SC-OR/262	For wire up to 0.5mm ø 115mm long
SC-OR/269	For wire up to 0.7mm ø
SC-OR/268	

## Side Cutter

Compound action, angled tungsten carbide jaw, gold handles, for Kirschner wire up to 1.6mm ø

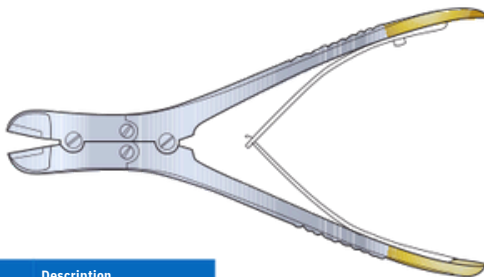

Code	Description
SC-OR/N060	180mm long

## Orthopaedic Plier/Cutter

Stainless steel

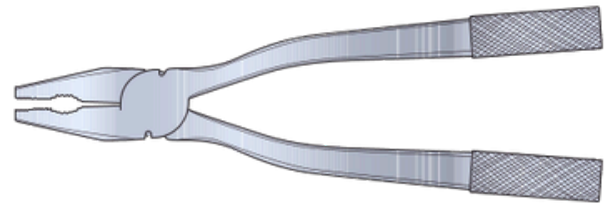

Code	Description
SC-OR/271b	180mm long
SC-OR/271c	220mm long

## Side Cutter

Gold handles, tungsten carbide edge, for cutting Kirschner wires up to 1.5mm ø

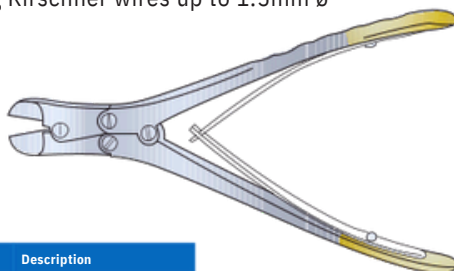

Code	Description
SC-OR/260	170mm long

## Bone Plate Bender/Wire Cutter Pliers

For nipping and breaking of soft wire only  
Not suitable for Kirschner wires

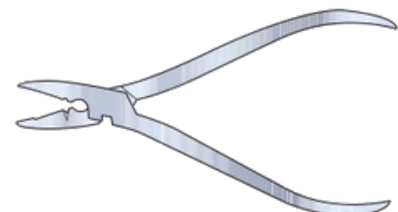

Code	Description
SC-OR/32a	150mm long



## Pliers for Wire

175mm long

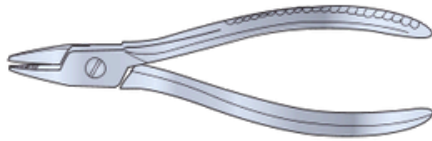

**Code**  
SC-OR/273



**Code**  
SC-OR/275

## Pliers for Bone Burrs

190mm long

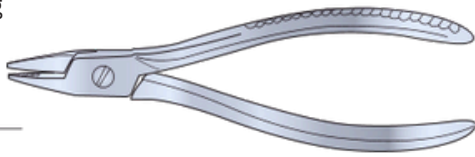

**Code**  
SC-OR/274

## Orthopaedic Plier/Cutter

Stainless steel, tungsten carbide edge, for cutting Kirschner wire up to 1.6mm

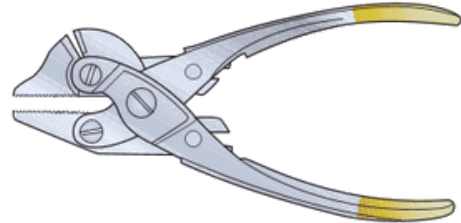

Code	Description
SC-	TC 180mm long
OR/271a	Non TC for cutting soft wire only, max cut 1.6mm, 180mm long
SC-	
OR/271b	

## Mole Grip Type Wrench

Stainless steel

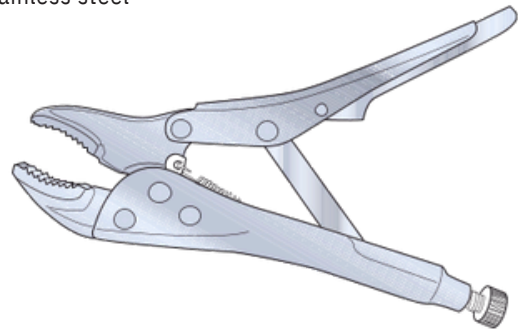

## Orthopaedic Pliers



Code	Description
SC-OR/49b	185mm

Code	Description
SC-OR/N052	190mm long

# Accessories

## Wire Twister Biomet Type



Code	Description
SC-OR/49a	150mm long

## Martin Cartilage Forceps

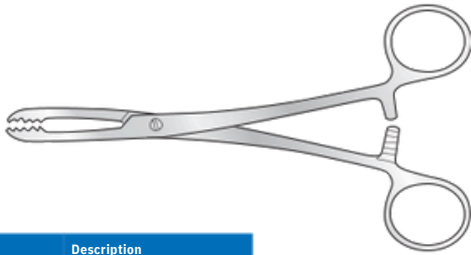

Code	Description
SC-OR/393	180mm long

## Charnley Suture Forcep

Slotted, 1-2 teeth



Code	Description
SC-OR/N045	180mm long

## Suture Wire Cutting Scissors

Angled to cut soft wire only, max cut 1.2mm

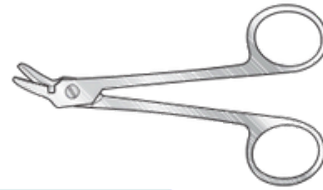

Code	Description
SC-OR/07b	120mm long

## Suture Wire Cutting Scissors



Code	Description
SC-OR/07c	110mm long

## Mallet

With serrated head, 170mm long



Code	Description
SC-OR/023	190 grams

## Mallet

Blue acetal, 240mm long

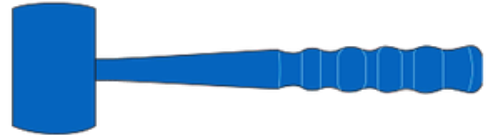

Code	Description
SC-OR/LE1001	340 grams, vertical end

## Mallet

Blue acetal "Suregrip" handle, 275mm long

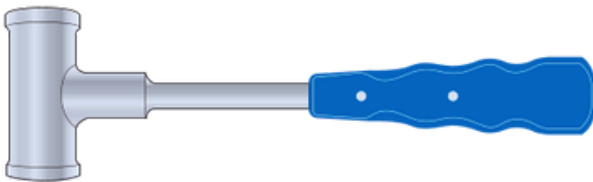

Code
SC-OR/270A-BH

## Mallet

Blue acetal, 255mm long

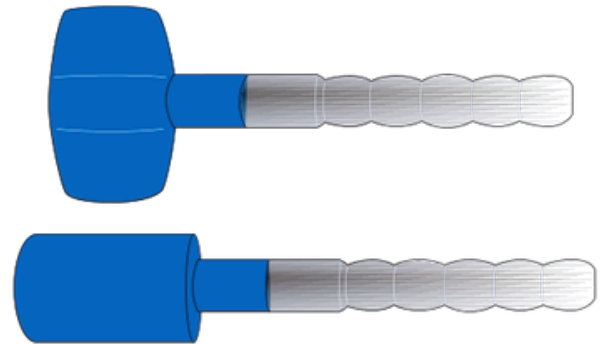

Code	Description
SC-OR/22a	520 grams, vertical end
SC-OR/22	650 grams, horizontal end

## Mallet

Stainless steel, 270mm long

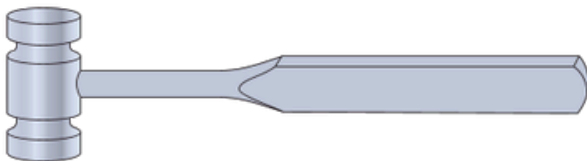

Code	Description
SC-OR/270	640 grams
SC-OR/271	1020 grams

## Heath Mallet

Stainless steel, 135mm long

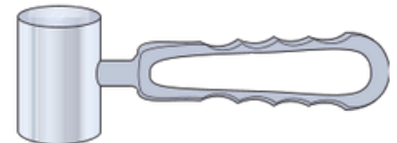

Code	Description
SC-OR/N044c	650 grams
SC-OR/N044b	920 grams

Code	Description
SC-OR/N044	1150 grams
SC-OR/N044a	1340 grams

## Mallet

Stainless steel, with pistol grip\*  
240mm long

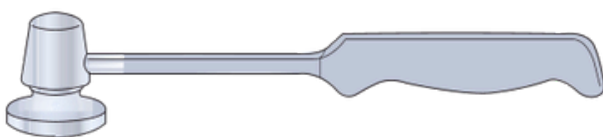

Code	Description
SC-OR/20	580 grams

\*ALSO AVAILABLE WITH  
BLUE ACETAL HANDLE

## Royal Cornwall Mallet

Stainless steel, with extended handle and strong welded head, 190mm long

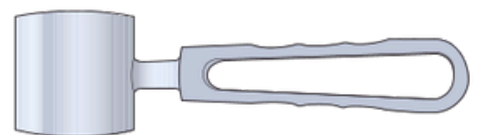

Code	Description
SC-OR/N044rc	1000 grams

## Mallets

### Orthopaedic Mallet

Surgical Holdings pattern, stainless steel, 170mm long

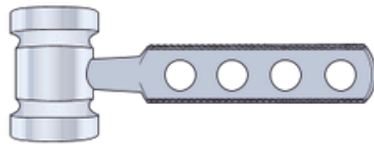

Code	Description
SC-OR/N055b	800 grams
SC-OR/N055	880 grams
SC-OR/N055a	1020 grams

### Orthopaedic Mallet

Stainless steel, Surgical Holdings pattern, one flat and one domed end, 180mm long

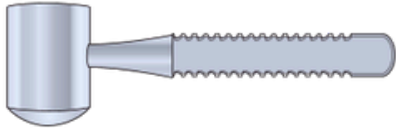

Code	Description
SC-OR/272a	960 grams
SC-OR/272c	750 grams

### ToEe Hammer

Stainless steel, one plain and one serrated side, 190mm long



Code	Description
SC-OR/N047	280 grams

### Ombredanne Mallet

Stainless steel, one flat and one domed end

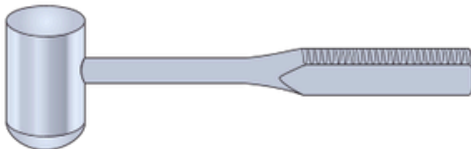

Code	Description
SC-OR/272	950 grams, 240mm long
SC-OR/272b	1110 grams, 270mm long

### Collin Mallet

Stainless steel, 205mm long



Code	Description
SC-OR/23	270 grams

### Kelsey Fry Mallet

With renewable acetal ends, 190mm long



Code	Description
SC-OR/N047a	280 grams
SC-OR/N048	Replacement end - pair

### Surgical Holdings Orthopaedic Mallet

Stainless steel with blue acetal "Suregrip" handle 270mm long



Code	Description
SC-OR/410	720 grams
SC-OR/411	800 grams

Code	Description
SC-	900 grams
OR/412	970 grams

SC-  
OR/413

### Surgical Holdings Orthopaedic Mallet

Stainless steel with blue acetal "Suregrip" handle 200mm long

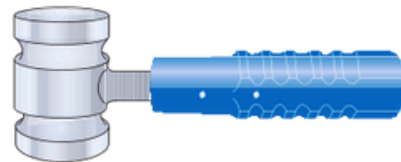

Code	Description
SC-OR/414BH	660 grams
SC-OR/415BH	790 grams

Code	Description
SC-OR/416BH	1020 grams
SC-OR/417BH	1400 grams

### Surgical Holdings Mallet

Stainless steel with blue acetal "Suregrip" handle domed faced head, 200mm long

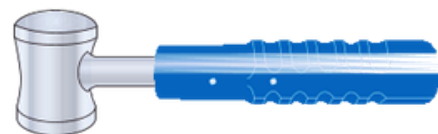

Code	Description
SC-OR/418BH	650 grams

## Putti Raspatory



Code	Description
SC-OR/12	300mm long

OTHER SHAPES AND CONFIGURATIONS ON REQUEST

## Bone File and Raspatory

Stainless steel



Code	Description
SC-OR/12a	215mm long

## Austin Moore Type Raspatory

Including tommy bar,  
295mm long

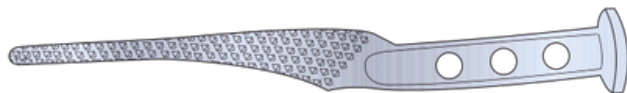

Code	Description
SC-OR/HP001	Standard
SC-OR/HP002	Narrow (not illustrated)

## Thompson Type Raspatory

Including tommy bar

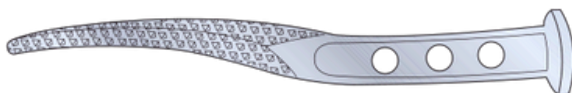

Many other types available  
 Supply a drawing of the prosthesis - we will make the rasp in any batch size you require.  
 The teeth will be chipped up at 0.75mm per face over and above the size of the prosthesis stem, to allow for cementing.

Code	Description
SC-OR/HP003	270mm long

## Miller Bone File

180mm long

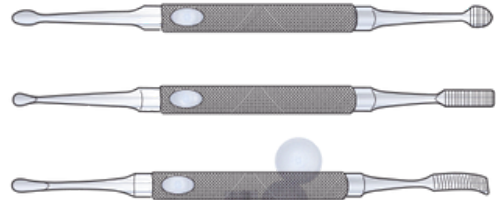

Code	Description
SC-OR/318	Short end
SC-OR/319	Slight curve
SC-OR/322	Full curve

## McGoey Punch

Double ended, 220mm long



Code	Description
SC-OR/N04	13 x 19mm
SC-OR/N04a	6 x 10mm
SC-OR/N04b	13 x 6mm half round

## Smillie Bone Punch



Head size 15 x 19.5mm

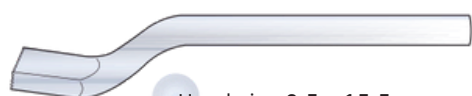

Head size 9.5 x 15.5mm

Code	Description
SC-OR/N018	Straight 140mm long
SC-OR/N019	Cranked 175mm long

# Pushers, Impactors and Skids

## Charnley Cup Pusher

With nylon head



Code	Description
SC-OR/N020	295mm long

## Hardinge Cement Restrictor

With T handle



Code	Description
SC-OR/HR001	335mm long

## Charnley Prosthesis Pusher

Stainless steel handle  
with nylon insert



Code	Description
SC-OR/N021	180mm long

## Moore Femoral Head Extractor

With T handle

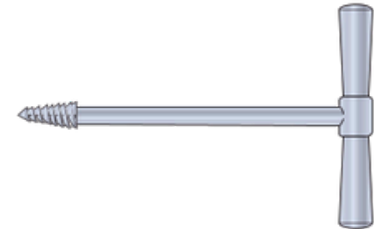

Code	Description
SC-OR/N005	150mm long
SC-OR/N006	205mm long

## Judet Impactor

Stainless steel handle  
with nylon head

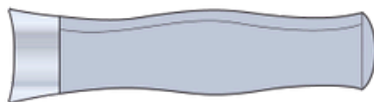

Code	Description
SC-OR/N009	140mm long

## Murphy Skids

Double ended, 355mm long



Code	Description
SC-OR/N007	Uncoated
SC-DIA/111	Coated

## Femoral Pusher

Head impactor, white Pomalux



Code	Description
SC-OR/N053	31mm ø x 180mm long

## Murphy Skids

Single ended, 330mm long



Code	Description
SC-OR/N007a	Coated

## Adson Periosteal Elevator

Serrated grip, 165mm long

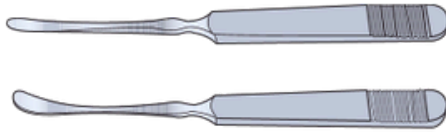

### straight

Code	Description
SC-OR/N028	7mm wide

### curved

Code	Description
SC-OR/N029	5mm wide
SC-OR/N030	7mm wide

## Langenbeck Elevator

Straight

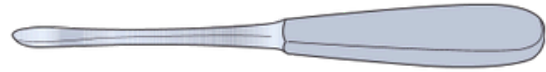

Code	Description
SC-OR/302	200mm long

## Bristow Periosteal Elevator

Sharp edge



Code	Description
SC-OR/N010	240mm long

## MacDonald Dissector Double Ended



Code	Description
SC-GI/285	191mm long

## Doyen Periosteal Elevator

Satin finish handle

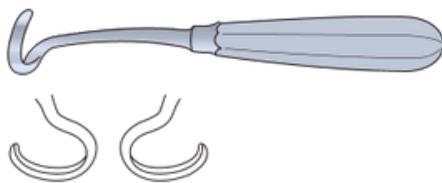

### 165mm long

Code	Description
SC-OR/N031	Right
SC-OR/N032	Left

### 180mm long

Code	Description
SC-OR/256	Right
SC-OR/255	Left

## Pennybacker Elevator

Curved, sharp, 6mm wide

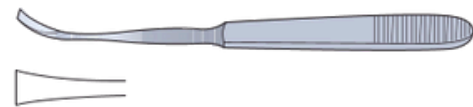

Code	Description
SC-OR/N025	170mm long

## Key Periosteal Elevator

190mm long



Code	Description
SC-OR/N023	10mm wide
SC-OR/N024	13mm wide

## Periosteal Elevator

Straight



Code	Description
SC-OR/19a	175mm long

# Elevators

## Periosteal Elevator

Straight, 12 x 20mm, with blue acetal "Suregrip" handle



Code	Description
SC-OR/SH-5695	195mm long

## Periosteal Elevator

Curved, 5 x 25mm, with blue acetal "Suregrip" handle



Code	Description
SC-OR/SH-5696	185mm long

## Tudor Edwards Periosteal Elevator

For first rib, satin finish handle, 175mm long

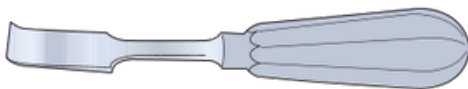

Code	Description
SC-OR/N026	12mm wide
SC-OR/N027	18mm wide

## Hohmann Bone Elevator

Matt finish, 160mm long



Code	Description
SC-OR/307a	6mm wide
SC-OR/307b	8mm wide
SC-OR/307d	10mm wide
SC-OR/307e	15mm wide

## Hohmann-Muller Spike Elevator

With narrow spade

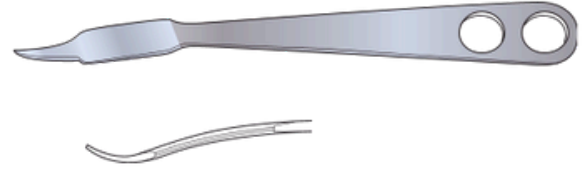

Code	Description
SC-OR/307f	220mm long, 10mm wide
SC-OR/307	230mm long, 12mm wide
SC-OR/308	240mm long, 18mm wide

## Hohmann-Aldinger Bone Elevator

Curved

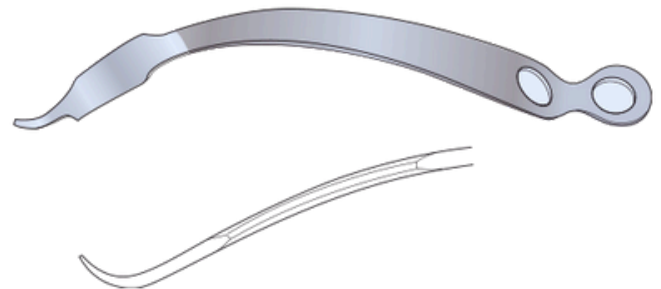

Code	Description
SC-OR/304	270mm long x 24mm wide

## Hohmann Bone Elevator

Curved

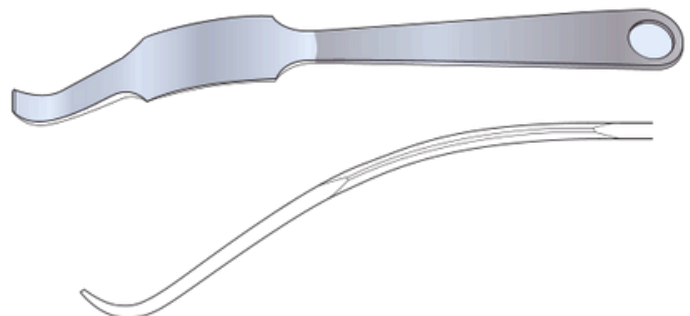

Code	Description
SC-OR/305	285mm long x 34mm wide



## Hohmann Bone Lever

Curved, Leicester Royal Infirmary pattern



Code	Description
SC-OR/LGH-HOH	340mm long x 23mm wide

## Wagner Bone Elevator

220mm long

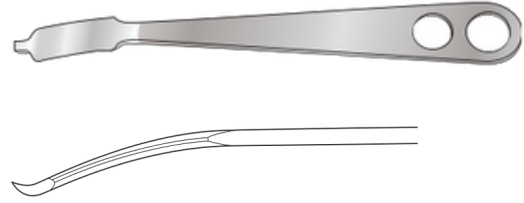

Code	Description
SC-OR/307n	17mm wide

## Schumacher Bone Elevator

290mm long

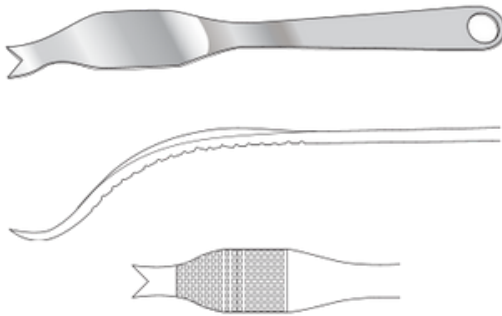

Code	Description
SC-OR/307k	59mm wide, 18mm at edge

## Lange-Hohmann Bone Elevator

250mm long

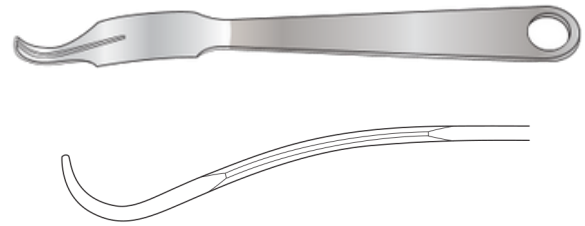

Code	Description
SC-OR/307l	24mm wide

## Muller Soft Tissue Retractor

40mm wide

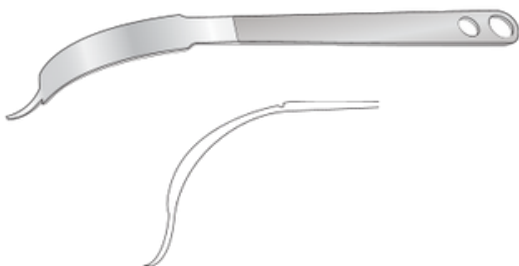

Code	Description
SC-OR/307aNOR	410mm long
SC-OR/307bNOR	300mm long

## Schumacher Bone Elevator

345mm long



Code	Description
SC-OR/307j	37mm wide, 18mm at edge

# Retractors and Bone Levers

## Fakuda Type Retractor

230mm long

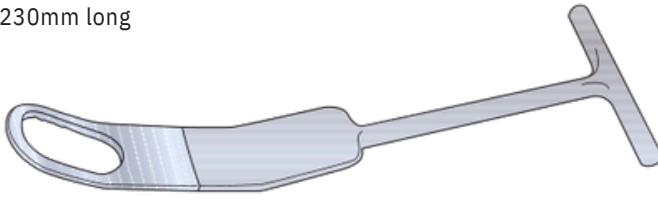

Code  
SC-OR/SH5507

## Trethowan Bone Lever

Bent, ring handle 222mm long, 280mm long

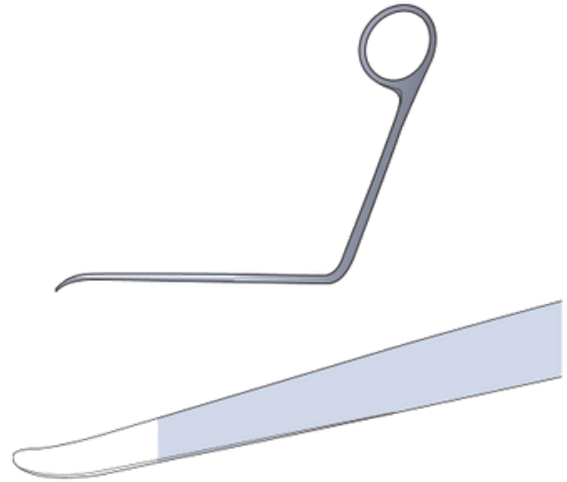

## Hohmann Retractor

45° angle, 200mm long



Code  
SC-OR/SH5394

Code	Description
SC-OR/no17b	90° angle
SC-OR/no17c	70° angle (illustrated)
SC-OR/no17d	45° angle

## Hohmann Tapered Spike Retractor

225mm overall length

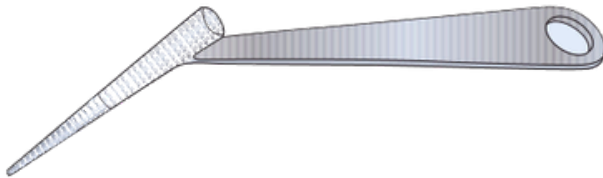

Code  
SC-OR/308a

## Posterior Bone Lever

230mm long



Code  
SC-OR/308r

## Gigli Saw Handles

Per pair

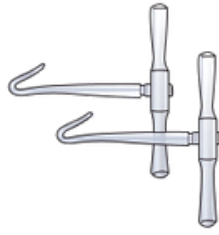

Code	Description
SC-OR/08	65mm long

## Guys Tenotomy Knife



Code	Description
SC-OR/N046	140mm long

## Charnley Saws

Code	Description
SC-OR/10c	500mm long
SC-OR/11c	700mm long

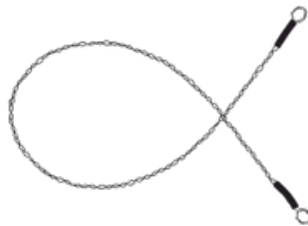

## Smillie Menisectomy Knife

175mm long



## Gigli Saws

Code	Description
SC-OR/09	300mm long
SC-OR/10	500mm long
SC-OR/11	700mm long

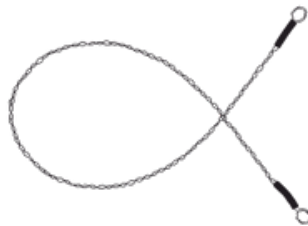

Code	Description
SC-OR/048	Straight

## Collin Rib Shears

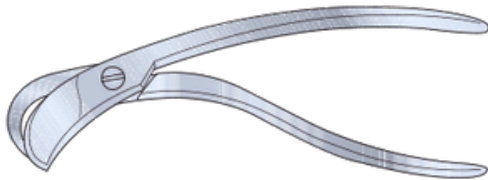

Code	Description
SC-OR/001	195mm long

## Smillie Menisectomy Knife

Protruding beak at base, 175mm long

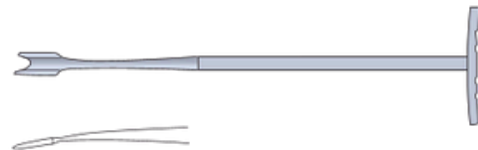

Code	Description
SC-OR/N0048a	Curved to right
SC-OR/N0048b	Curved to left

# Screw and Plate Instruments

## Allen Key Sets

Bright guard



Code	Description
SC-OR/N051	1.5mm - 10mm

To order quote SC-OR/N051 then add size required e.g. SC-OR/N051-1.5

Size mm	Overall Length
1.5	63mm
2.0	77mm
2.5	87mm
3.0	93mm
4.0	104mm
5.0	120mm
6.0	141mm
7.0	147mm
8.0	158mm
10.0	180mm

## Orthopaedic Ruler Stainless Steel



Code	Description
SC-OR/51a	Metric, 300mm

# Pins

## Denham Pin

Temporary implants, material conforms to BS 7252: Part 1: 1997. ISO 5832-1: 1997. Comp.D. CE marking available on request.



Code	Size
SC-DP/1-3SE	3.96mm dia x 203mm long trocar/3 side end
SC-DP/1SQ	3.96mm dia x 203mm long trocar/square end
SC-DP/2-3SE	3.96mm dia x 229mm long trocar/3 side end
SC-DP/2SQ	3.96mm dia x 229mm long trocar/square end

Code	Size
SC-DP/3-3SE	4.76mm dia x 203mm long trocar/3 side end
SC-DP/3SQ	4.76mm dia x 203mm long trocar/square end
SC-DP/4-3SE	4.76mm dia x 229mm long trocar/3 side end
SC-DP/4SQ	4.76mm dia x 229mm long trocar/square end

THREE SIDED END OR SQUARE END IN STOCK  
OTHER SIZES AVAILABLE

## Steinmann Pins

Temporary implants, material conforms to BS 7252: Part 1: 1997. ISO 5832-1: 1997. Comp.D. CE marking available on request

Various specs available – contact us for full information

Ø mm*	Ø mm*
1.58	3.96
2.00	4.36
2.38	4.76
2.78	6.00
3.17	6.35
3.57	8.00

LENGTHS 150, 180, 200, 250mm  
\*Other lengths and diameters available

When ordering, use prefix letters with size following  
e.g. Trocar with one screw end  
Ø4.76mm = IPTS/476



IPTT = trocar/trocar ends



IPTS = trocar/trocar with one screw end



IPTSE = trocar/square end



IPTSE3 = trocar/with 3 sided end

## Bohler Stirrup

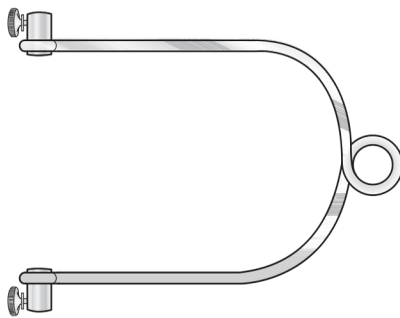

Code	Description
SC-OR/N001	Small 89 x 102mm
SC-OR/N002	Medium 114 x 165mm
SC-OR/N003	Large 152 x 241mm

## Steinmann Pin Cap with Screw

Code	Description
SC-OR/54b-4	4mm ø
SC-OR/54c	Replacement screw



SC-OR 54b

## Fine Hand Set

Includes: small stille type mallet 17cm long and 2mm, 4mm, 6mm, 8mm, 10mm and 12mm osteotomes

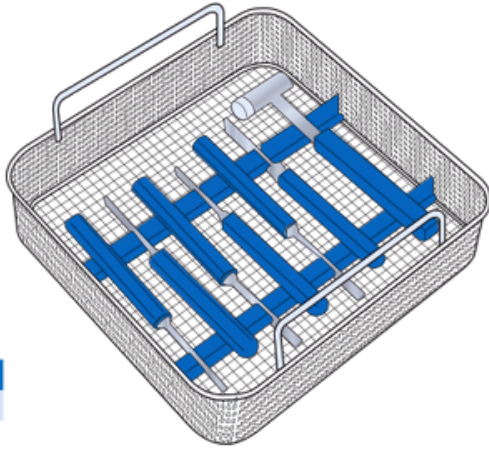

**Code**  
SH-6969

## Mini-Lexer Gouges

With blue acetal handle



Code	Description
SC-OR/587-04	4mm wide, 18cm long
SC-OR/587-06	6mm wide, 18cm long
SC-OR/587-08	8mm wide, 18cm long
SC-OR/587-10	10mm wide, 18cm long

## Flexible Chisels and Blades

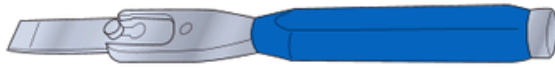

Code	Description
SC-OR/593	Allen key for flat chisel blades introducer handle 185mm long
SC-OR/594	Chisel blade 5mm for introducer handle
SC-OR/594A	Chisel blade 5mm curved for introducer handle
SC-OR/595	Chisel blade 10mm for introducer handle
SC-OR/595A	Chisel blade 10mm curved for introducer handle
SC-OR/596	Chisel blade 15mm for introducer handle
SC-OR/596A	Chisel blade 15mm curved for introducer handle
SH-6954	Introducer handle for flat chisel blades 185mm long

## Mini-Lexer Osteotome and Gouge Set

Includes 4mm, 6mm, 8mm, 10mm gouges 18cm long and 2mm, 4mm, 6mm, 8mm and 10mm osteotomes 18cm long

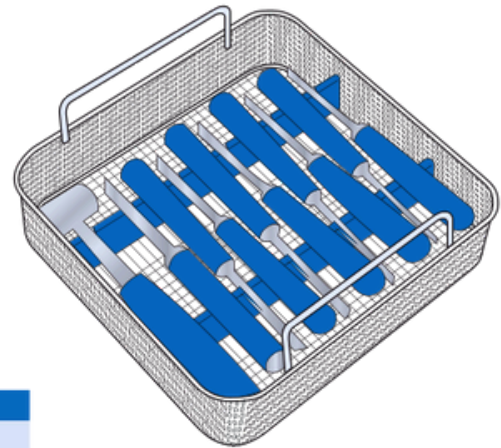

**Code**  
SC-OR/587

## Mini Fine Hand Osteotomes

With blue acetal handle



Code	Description
SH-6956	2mm wide, 165mm long
SH-6957	4mm wide, 165mm long
SH-6958	6mm wide, 165mm long
SH-6959	8mm wide, 165mm long
SH-6960	10mm wide, 165mm long
SH-6961	12mm wide, 165mm long

## Mini-Lexer Osteotomes

With blue acetal handle



Code	Description
SC-OR/588-02	2mm wide, 18cm long
SC-OR/588-04	4mm wide, 18cm long
SC-OR/588-06	6mm wide, 18cm long
SC-OR/588-08	8mm wide, 18cm long
SC-OR/588-10	10mm wide, 18cm long

## Removable Flexible Chisel and Blade Set

With blue acetal handle

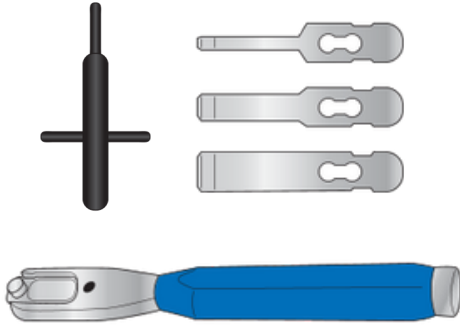

Code	Description
SH-7002	5mm, 10mm and 16mm straight
SH-7002A	5mm, 10mm and 16mm curved

## Chirobloc Hand Immobiliser



Code	Description
CB3	Chirobloc 3 with wrist strap and 5 ForgetMeNots
CBL	Chirobloc Ballast
CBM	Chirobloc Large
CBP	Chirobloc Small
FMN2B.B	Chirobloc ForgetMeNot Blue
FMN2B.Y	Chirobloc ForgetMeNot Yellow

## Small Mallet

Small mallet 340 gram 210mm long with one flat and one round end fitted with blue acetal handle

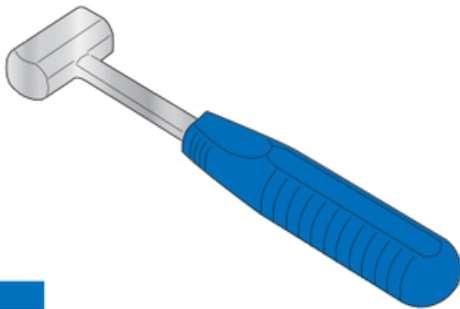

Code
SH-6955

## Small Stille Type Mallet

Ultra fine mallet 180mm long with one nylon head fitted with a blue acetal handle 180 gram

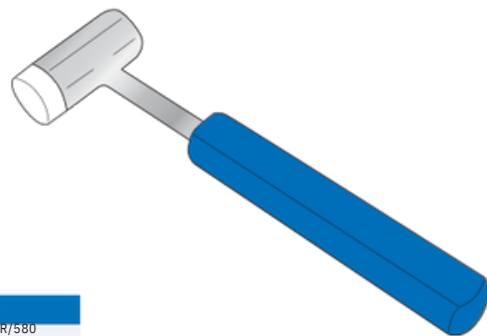

Code
SC-OR/580

# Shoulder Instruments

## Kolbel Soft Tissue Retractor

Single-pronged, angled, 190mm

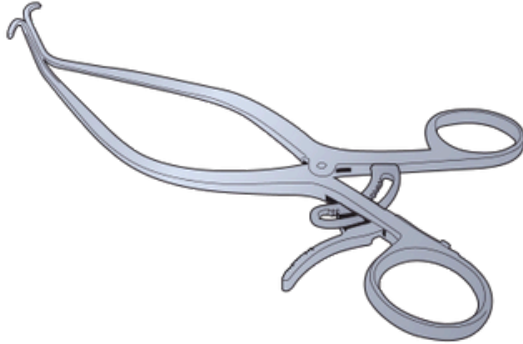

Code  
SH004637943

## Kolbel Soft Tissue Retractor

Single-pronged, straight, very fine tips, 190mm

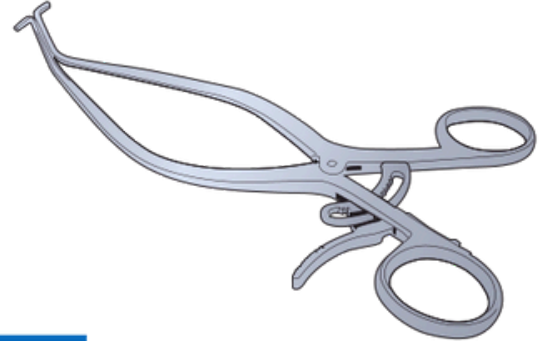

Code  
SH004636943

## Kolbel Soft Tissue Retractor

Double pronged, angled, 190mm

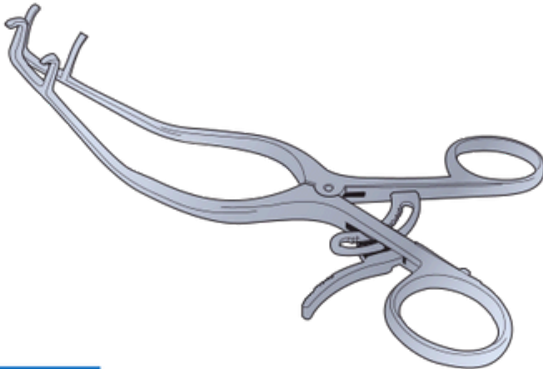

Code  
SH004454965

## Capsule Spreader

Single-pronged, fine, 90° curved, 165mm

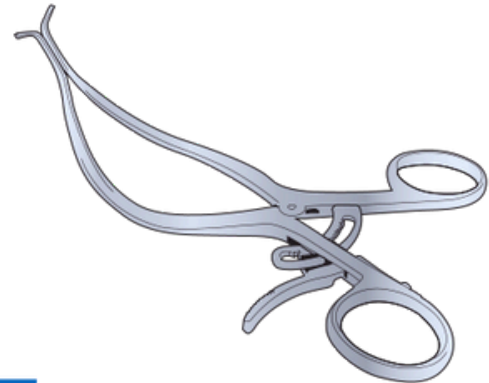

Code  
SH004455954

## Fukuda-Kujat Humeral Head Retractor

35mm, wide blade, 225mm

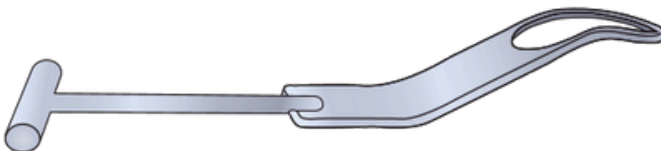

Code  
SH0046351113

## Kolbel Self Retaining Glenoid Retractor

With ball snap-fit, slightly curved, 200mm



**Code**  
SH004459965

## Kolbel Glenoid Retractor

Double-pronged, angled tips, 300mm, 18mm straight



**Code**  
SH004458416

## Kolbel Glenoid Retractor

Double-pronged, angled tips, 300mm, 15mm strongly curved



**Code**  
SH004457V318416

## Pair of Kolbel Self Retaining Glenoid Retractor Blades

With ball fit

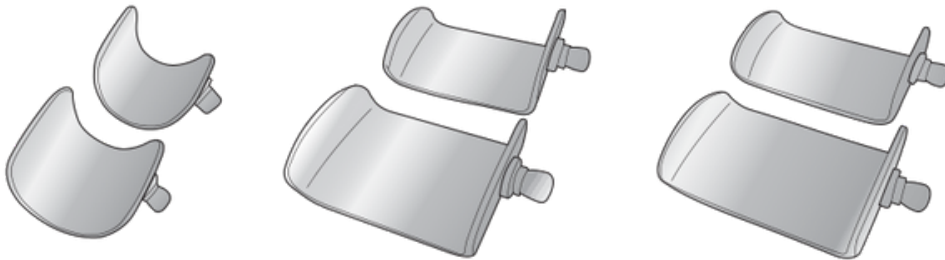

Code	Description
SH004460954	Pair of blades size 36 x 36mm
SH004461V316	Pair of blades size 53 x 36mm
SH004462V319	Pair of blades size 68 x 36mm



# Thank You!



Website: [www.tetraind.com](http://www.tetraind.com)  
Email: [info@tetraind.com](mailto:info@tetraind.com)  
Whatsapp: +92-329-7598399  
Cell: +92-329-7598399  
Address: Shahab pura  
P.O Head Office 51310  
Sialkot - Pakistan.  
E- [tetraindustries01@gmail.com](mailto:tetraindustries01@gmail.com)  
Mail:



ایوان صنعت و تجارت سialکوت

AN ELEMENTARY TRUSTEE  
FOR BUSINESS EXPANSION