

TETRA INDUSTRIES

Ear, Nose & Throat

CATALOG



TETRA
INDUSTRIES

Ear, Nose & Throat

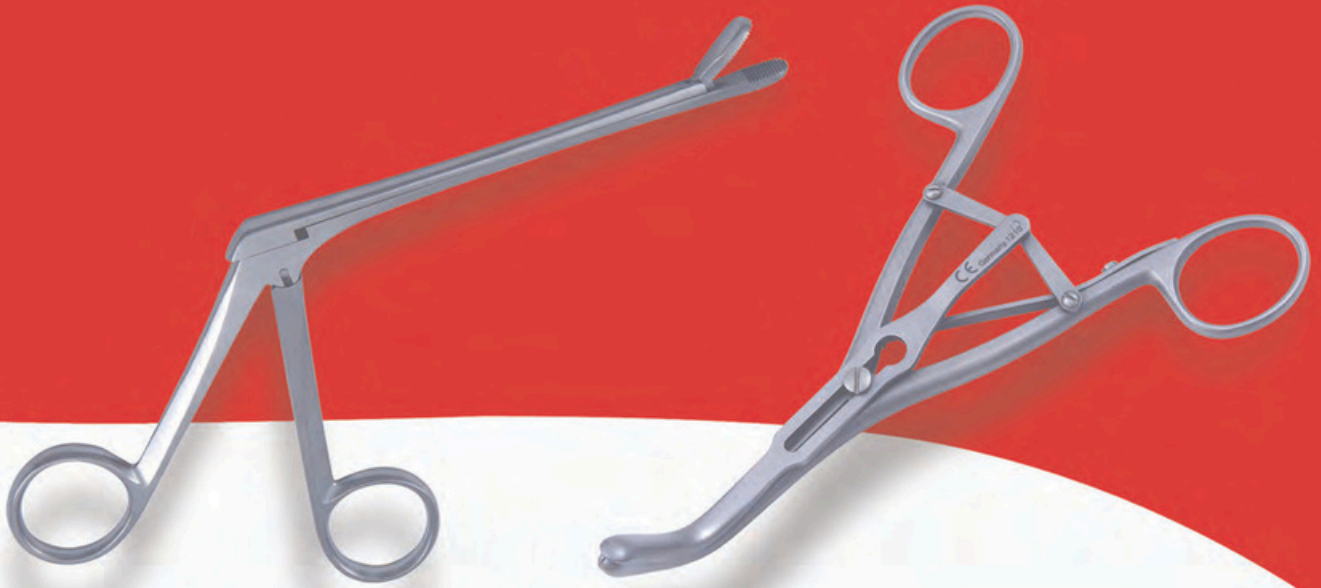

Adenotomes	ENT-2	Foot Plate Hooks	ENT-43	Presses	ENT-93
Arch Bars	ENT-3	Forceps	ENT-44	Probes	ENT-94
Awls	ENT-3	Handles	ENT-64	Punches	ENT-95
Brushes	ENT-3	Hooks	ENT-64	Rasps	ENT-100
Calipers	ENT-4	Inserters	ENT-71	Retractors	ENT-106
Cannulas	ENT-4	Instrument Covers	ENT-71	Rongeurs	ENT-118
Chisels	ENT-5	Knives	ENT-72	Saws	ENT-123
Clamps	ENT-7	Laryngoscope	ENT-79	Scissors	ENT-123
Connectors	ENT-7	Loops	ENT-79	Snares	ENT-138
Containers	ENT-8	Mallets	ENT-79	Speculums	ENT-139
Crushers	ENT-8	Mirrors	ENT-80	Spreaders	ENT-145
Curettes	ENT-9	Mobilizers	ENT-80	Suction Tubes	ENT-145
Cutting Blocks	ENT-18	Mouth Gags	ENT-81	Syringes	ENT-148
Dilators	ENT-18	Needles	ENT-83	Tracheal Tubes	ENT-148
Dissectors	ENT-19	Nippers	ENT-85	Trocars	ENT-148
Elevators	ENT-20	Sponges	ENT-86	Tuning Forks	ENT-149
Energy	ENT-30	Osteotomes	ENT-86	Wire Guides	ENT-149
Excavators	ENT-43	Picks	ENT-89		

Adenotomes (Tonsil & Laryngeal)



71-1010

Laforce Adenotome

CODE	DESCRIPTION	WIDTH
71-	Infant	8.0 mm
1000 7	#0 Child	11 mm
1-1010	#1 Small	12 mm
7 1-	#2 Medium	16 mm
1011 7	#3 Large	18 mm
1-1012		
7 1-		
1013		

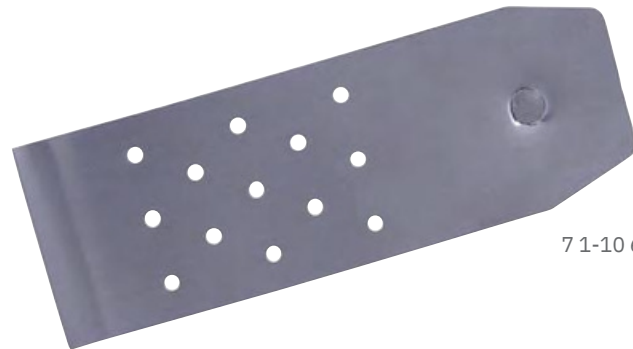

71-1063

Adenotome Blades

CODE	DESCRIPTION	WIDTH
7 1-10	Blade, Infant	8.0 mm
50 71-	Blade #0, Child	11 mm
1060	Blade #1, Small	12 mm
71-	Blade #2, Medium	16 mm
1061 7	Blade #3 Large	18 mm
1-10		
62 7 1-		
10 6 3		

Arch Bars

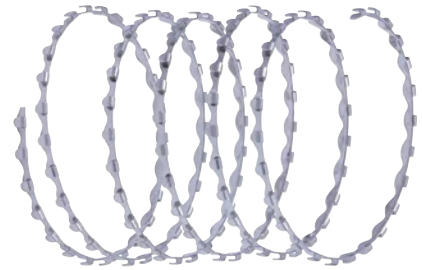

68-1505

Erich Arch Bar

CODE	DESCRIPTION
68-1505	1 Meter Roll
68-1510	Pack of 12 , 5 ½ in (140 mm) Long

Awls (Sinus & Nasal)



Obwegeser Zygomatic Arch Awl

CODE	DESCRIPTION	LENGTH
68-0410	Cur ved	9 ½ in241 mm

Brushes (Laryngoscope Cleaning)



74-6973

Laryngoscope Cleaning Brush

CODE	LENGTH
74-	10 in270 mm
6971	11 280
74-	in mm
6972	11 280
74-	in mm
6973	

Calipers (Middle Ear)



Austin Strut Calipers

CODE	DESCRIPTION	LENGTH
61- 0310	Markers at 3.5 mm, 4.0 mm and 4.5 mm From Tip	6 in 150 mm

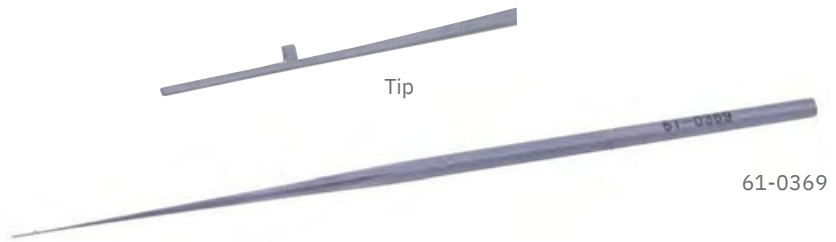

House Strut Calipers

CODE	DESCRIPTION	LENGTH
61-	Marker 3.5 mm From	6 ½ in 165
0367	Tip Marker 4.0 mm	6 ½ in mm
61-	From Tip Marker 4.5	6 ½ in 165
0368	mm From Tip	mm
61-		165
0369		mm

Cannulas (Sinus & Nasal, Sinus, Sinus Suction Cannula)

Killian Antrum Cannula

CODE	DESCRIPTION	LENGTH
66-6022	3.5 mm Tip	6 in 150 mm

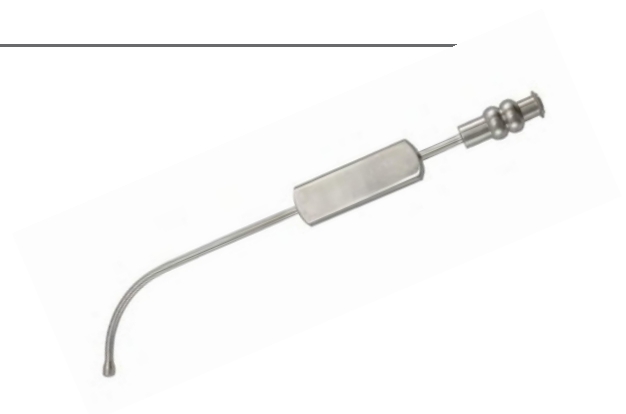

Cannulas (Sinus & Nasal, Sinus, Sinus Suction Cannula)

Van Alyea Sinus Cannula

CODE	DESCRIPTION	LENGTH
66-6042	2.0 mm, Slight Curve	6 in 150 mm



Sinus Suction Cannula

CODE	DESCRIPTION	LENGTH
63-7567	2.5 mm Short Curve	5 3/4 145 mm
63-7562	3.0 mm Short Curve	in 5 mm
63-7564	4.0 mm Short Curve	3/4 in 145 mm
63-7566	2.5 mm Long Curve	5 3/4 mm
63-7560	3.0 mm Long Curve	in 5 145 mm
63-7565	4.0 mm Long Curve	3/4 in mm
		5 3/4 145 mm
		in mm
		5 3/4 145 mm
		in mm
		145 mm



Cannulas (Trocar and Cannula)

Sinuscopy Trocar and Cannula

CODE	TIP SIZE	LENGTH
09-5228	3.5 mm	6 3/4 in 170 mm
09-5229	5.0 mm	6 3/4 in 170 mm

Chisels (Middle Ear, Sinus & Nasal)

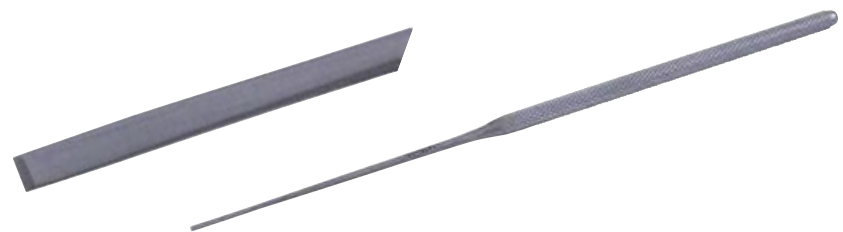

Austin Chisel

CODE	DESCRIPTION	TIP WIDTH	LENGTH
61-0311	Straight	1.0 mm	6 3/4 in 160 mm

Chisels (Middle Ear, Sinus & Nasal)

Ballenger Chisel

V-Shaped Edge



63-0091

CODE	DESCRIPTION	LENGTH
63-0088	2 mm	6 ¼ 160
63-0089	Wide 4	in 6 mm
63-0090	mm Wide	¼ in 160
63-0091	6 mm	6 ¼ mm
	Wide 8	in 6 160
	mm Wide	¼ in mm
		160
		mm



Tip

Cottle Chisel

with Centimeter Markings at 40 mm, 60 mm and 70 mm

CODE	DESCRIPTION	LENGTH
6 3 - 0110	Cur ved	7 ¼ in 185 mm



Chisel

CODE	DESCRIPTION	LENGTH
68-0404	Single Bevel, 4 mm Tip, Round Handle	6 ¾ in 170 mm

Freer Chisel

CODE	DESCRIPTION	LENGTH
63-0084	Straight, 5 mm Wide	6 ¾ 170
63-0085	Curved, 5 mm Wide	in 6 mm
		¾ in 170
		mm

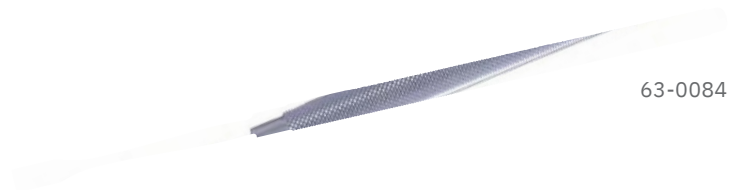

63-0084

Clamps (Sinus & Nasal, Middle Ear)

Cottle Columella Clamp

CODE	DESCRIPTION	JAW WIDTH	LENGTH
67-5860	With Adjusting Screw	14 mm	4 3/8 in 110 mm



Tip



Derlacki Ossicle Holding Clamp

CODE	DESCRIPTION	VERTICAL GROOVE	HORIZONTAL GROOVE	LENGTH
61-0511	1.0 mm Teeth	1.5 x 4 mm	1.5 x 2 mm	4 3/4 in 120 mm



Tip



Sheehy Ossicle Holding Clamp

CODE	DESCRIPTION	VERTICAL GROOVE	LENGTH
61-0512	5 mm Teeth	1.5 x 4 mm	4 3/4 in 120 mm

Connectors (Middle Ear)

House Cut-Off Adapter

CODE	DESCRIPTION
61-1045	for Use with Rosen Suction



LENGTH
2 in 50 mm

Containers (Tray, Middle Ear)

Metapak Tray

Stainless Steel

CODE	DESCRIPTION	HEIGHT	
7322-03-	Half Length Tray	2	50
200S 7 310 -	Full Length Tray	in	mm
03 -20 0A		2	50
		in	mm



Paparella Instrument Rack

61-3835

CODE	DESCRIPTION
61-3835	Holds up to 20 Instruments, for Tympanoplasty and Stapes Instruments

Crushers (Cartilage)



67-1970

Cottle Cartilage Crusher

CODE	DESCRIPTION
67-1970	Cartilage Crusher

Curettes (Adenoid)



71-3610

Barnhill Adenoid Curette

CODE	SIZE	BLADE	LENGTH
71-	0	10 mm	8 ¾ in 220
3610	1	12 mm	8 ¾ in mm
71-	2	14 mm	8 ¾ in 220
3612 7	3	16 mm	8 ¾ in mm
1-3614	4	18 mm	8 ¾ in 220
71-	0	10 mm, Reverse Curve	8 ½ in mm
3616	1	12 mm, Reverse Curve	8 ½ in 220
71-	2	14 mm, Reverse Curve	8 ½ in mm
3618	3	16 mm, Reverse Curve	8 ½ in 220
71-	4	18 mm, Reverse Curve	8 ½ in mm
3810			215
71-			mm
3812 7			215
1-3			mm
814			215
71-			mm
3816			215
71-			mm
3818			215
			mm

Curettes (Adenoid)

Jones Adenoid Curette

CODE	DESCRIPTION	BLADE SIZE	LENGTH
71-3800	Infant Size	4 mm 6	8 ¾ in 8 220
71-3801	Child Adult	mm 8 mm	¾ in 8 mm
71-3802			¾ in 220
			mm
			220
			mm

Middleton Adenoid Curette

CODE	DESCRIPTION	BLADE SIZE	LENGTH
71-3209	Infant Size	8 mm	8 ¾ in 220 mm

Curettes (Adenoid)



Stubbs Adenoid Curette

CODE	DESCRIPTION	BLADE	LENGTH
7 1 -	Infant Size	4 mm	8 ¾ in 220
4111	Child Adult	6 mm	¾ in 8 mm
71-		8 mm	¾ in 220
4113			mm
71-			220
4115			mm

Vogel Adenoid Curette

CODE	DESCRIPTION	BLADE	LENGTH
71-3208	Infant Size	7 mm Wide	8 ½ in 215 mm

Curettes (Bone)



Lempert Bone Curette

Oval, Straight, Delicate

CODE	TIP	LENGTH
29 - 6706	#6/0	8 in 8 in 200 mm
29-6715	#5/0	8 in 8 in 200 mm
29-6724	#4/0	8 in 8 in 200 mm
29-6733	#3/0	8 in 8 in 200 mm
29-6742	#2/0	200 mm
29-6750	#0	200 mm
29-6751	#1	200 mm
29-6752	#2	200 mm

Curettes (Double-Ended, Ear)



68-0004

Lucas Curette

CODE	SIZE	LENGTH
68-0004	#5	7 in 175 mm



68-0225

Exodontia Oral Double-Ended Curette

CODE	TIP	LENGTH
68-	#1	7 ¼ in 185 mm
0225	0	7 ¼ in 185 mm
68-	#1	7 ¼ in 185 mm
0227	2	
68-	#1	
0228	3	



29-6750

Buck Ear Curette

CODE	SIZE	TIP	DIAMETER	LENGTH
62-	#00	Blunt, Slightly Angled	1.0 mm	6 in 6 in 150
1309	#0	Tip Blunt, Slightly	1.5 mm	6 in 6 in mm
62-	#1	Angled Tip Blunt,	2.0 mm	6 in 6 in 150
1310	#2	Slightly Angled Tip	2.5 mm	6 in 6 in mm
62-	#3	Blunt, Slightly Angled	3.0 mm	6 in 6 in 150
1311	#00	Tip Blunt, Slightly	1.0 mm	mm
62-	#0	Angled Tip Sharp,	1.0 mm	150
1312	#1	Slightly Angled Tip	2.0 mm	mm
62-	#2	Sharp, Slightly Angled	2.5 mm	150
1313	#3	Tip Sharp, Slightly	3.0 mm	mm
62-		Angled Tip Sharp,		150
1209		Slightly Angled Tip		mm
62-		Sharp, Slightly Angled		150
1210		Tip		mm
62-				150
1211				mm
62-				150
1212				mm
62-				150

Curettes (Ear)

6 2-14 3 2

Shapleigh Ear Curette

CODE	DESCRIPTION	BLADE	LENGTH
62-1431	Small, Very	1.5 mm Serrated Loop	6 ½ in 165 mm
62-1432	Delicate Large, Very Delicate	2 mm Serrated Loop	6 ½ in 265 mm

Curettes (Ear, Elevator & Curette, Ear)

6 2-1470

Gross Ear Spoon & Hook

CODE	DESCRIPTION	LENGTH
62-1470	Double - Ended	4 ¾ in 120 mm

63-0409

Dunning Elevator & Curette

CODE	SIZE
63-0409	Sharp End 3 x 5 mm, Spatula End 3 mm

61-0015

Sprague Ear Curette

CODE	SIZE	TIP	LENGTH
61- 0	Small	2	7 in 7 in 175
015 61-	Large	mm	mm
0 016		3	175
		mm	mm

Curettes (Frontal Sinus)



63-8810

Frontal Sinus Curette

Small Oblong

CODE	DESCRIPTION	CUP SIZE	LENGTH
63-8805	Straight	2 x 5	7 ½ 190
63-8810	45° Angle	mm 2 x	in 7 mm
63-8815	90° Angle	5 mm 2	½ in 190
		x 5 mm	7 ½ mm
			in 190
			mm



11-601

Access Frontal Sinus Curette

With Swivel Luer

CODE	DESCRIPTION	ANGLE
11-	Frontal	0°
601	Sinus	50°
11- 6	Frontal	90°
51	Sinus	
11-	Frontal	
691	Sinus	



11-642S

Access Suction Curette

CODE	DESCRIPTION
11-	45°
642S	90°
11-	
692S	

Curettes (Middle Ear)

Ethmoid Curette

CODE	DESCRIPTION	SIZE	LENGTH
63-0058	Curette	3 x 5 mm Cup	8 in 200 mm



Guilford-Wright Micro Curette

CODE	DESCRIPTION	ANGLE	CUP	LENGTH
61-	Small	Light Angle	1 mm Cup	5 ½ 140
0327	Medium	Light Angle	1.5 mm Cup	in 5 mm
61-	Large	Strong Angle	2 mm Cup	½ in 140
0328				5 ½ mm
61-				in 140
0329				mm



61-0348

Hough Curette

CODE	DESCRIPTION	SIZE	LENGTH
61-0348	Angled 35°, Serrated Cup	2 x 3 mm	5 ½ in 140 mm

Curettes (Middle Ear)



61-0398

Halle Hough Curette

CODE	DESCRIPTION	SIZE	LENGTH
61-0398	Lightly Angled	2 x 2.5 mm	6 ½ 165
61-0399	Strongly Angled	Cups 2 x 2.5	in 6 mm
61-0398E	Ebonized	mm Cups 2 x 2.5 mm Cups	½ in 165 mm



House-Sheehy Knife Curette

Malleable Shaft

CODE	DESCRIPTION	BLADE	LENGTH
61-0381	"Small	2 mm	6 ½ 165
61-0382	Weapon" "Large Weapon"	2.5 mm	in 6 mm ½ in 165 mm



House Stapes Curette

CODE	DESCRIPTION	SIZE	LENGTH
61-0380	Double - Ended	1.7 mm and 2 mm	6 in 150 mm

Curettes (Middle Ear)



House Stapes Curette

CODE	DESCRIPTION	SIZE
61-3725	Double-Ended, Strong Angle	1.7 mm and 1.9 mm



Paparella Ring Curette

CODE	DESCRIPTION	TIP	LENGTH
61-37 7 5	Angled, Blunt	1.5 mm	6 ½ in 165 mm

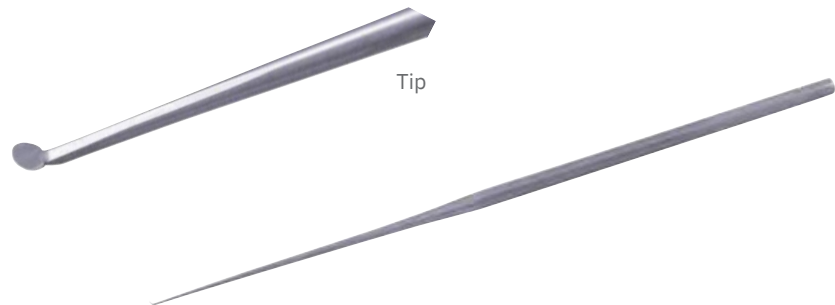

Rosen Knife Curette

CODE	DESCRIPTION	ANGLE	BLADE	LENGTH
61-0450	Small Large	Angled 45°	2 mm	6 ¼ in 160
61-0451		Angled 45°	2.5 mm	6 ¼ in mm
				160
				mm

Curettes (Sinus & Nasal)

Antrum Curette

Fenestrated Cup

CODE	DESCRIPTION	SIZE	LENGTH
63-7540	Backward Cut	7 x 10 mm	7 ½ in 190
63-7535	Forward Cut	Tip 7 x 10 mm Tip	in 7 mm ½ in 190 mm

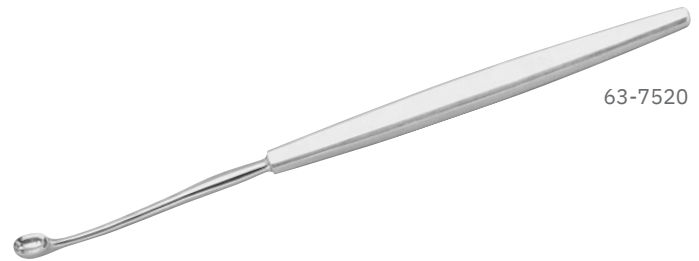

Antrum Curette

CODE	DESCRIPTION	CUP	LENGTH
63-7512	Straight	3 x 9 mm	7 ½ in 190 mm
63-7505	Straight	7 x 11 mm	7 ½ in 190 mm
63-7515	Straight	8 x 11 mm	7 ½ in 190 mm
63-7520	Straight	9 x 13 mm	7 ½ in 190 mm
63-7510	Angled Up	1.5 x 6 mm	7 ½ in 190 mm



Coakley Antrum Curette

Single - Ended

CODE	DESCRIPTION	LENGTH
66-5801	#1	6 ¾ in 170 mm
66-5802	#2	6 ¾ in 170 mm
66-5803	#3	6 ¾ in 170 mm
66-5804	#4	6 ¾ in 170 mm
66-5805	#5	6 ¾ in 170 mm
66-5806	#6	6 ¾ in 170 mm

Curettes (Sinus & Nasal)



Faulkner Antrum Curette

Double-Ended, Malleable Shaft

CODE	DESCRIPTION	LENGTH
63-7500	5 mm and 8 mm Rings	9 in 230 mm

Cutting Blocks



61-0699

Cutting Block

CODE	DESCRIPTION	WIDTH	LENGTH
61-0699	Teflon Cutting Block	1 ½ in 38 mm	3 in 76 mm

Dilators (Tracheal)



25-4002

Laborde Tracheal Dilator

CODE	DESCRIPTION	BLADES	JAW WIDTH	JAW THICKNESS	LENGTH
25-	Tri-Valve		1 3/4 in 5.0 mm	1/4 in 6.0 mm	6 3/4 in 170 mm
4002	Child	Three Blades, Two Flat, One Cupped			6 3/4 in 170 mm
73-73-6603-6604	Adult	Three Blades, Two Flat, One Cupped			6 3/4 in 170 mm

Dilators (Tracheal)



Trousseau Tracheal Dilator

CODE	DESCRIPTION	BLADES	JAW WIDTH	JAW THICKNESS	LENGTH	
73-6602	Adult	Two	Blades,		6 ¾ in 170 mm	
73-6601	Child	Curved	Two		6 ¾ in 170 mm	
25-4000	Closed	Blades,	Curved	¼ in 6 mm	¾ in 16 mm	6 ¾ in 170 mm
25-5569	Closed	Two	Blades,	1/8 in 3 mm	1/8 in 3 mm	6 ¾ in 170 mm
		Curved	Two			
		Blades, Curved				

Dissectors (Facial)



McCabe Facial Nerve Dissector

CODE	DESCRIPTION	JAW LENGTH	LENGTH
62-1585	Smooth Angled Jaws	14 mm	5 ½ in 140 mm

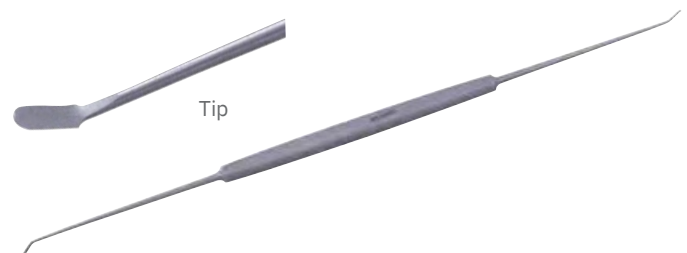

McCabe Flap Knife Dissector

Double - Ended

CODE	DESCRIPTION	BLADE	LENGTH
62-0480	Angled 25° and 45°	2 x 3 mm	7 ¼ in 185 mm

Elevators (Mastoid Hook & Searcher)

Allport Mastoid Hook & Searcher

CODE	DESCRIPTION	LENGTH
62-1520	Angled 90°	6 ¼ in 160 mm

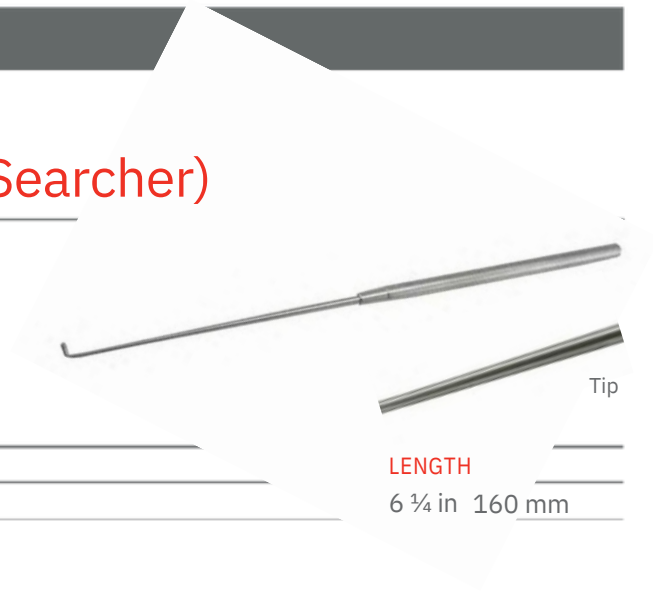

Elevators (Middle Ear, Cleft Palate, Ball End)

Jordan Canal Elevator

CODE	DESCRIPTION	LENGTH
61- 0416	2 mm Sharp Blade, Angled 60°	6 ½ in 165 mm



Blair Cleft Palate Elevator

CODE	DESCRIPTION	TIP	LENGTH
67-1749	Blair Cleft	L-Shaped	7 ½ in 190 mm



Elevators (Middle Ear, Cleft Palate, Ball End)

Cronin Cleft Palate Elevator



CODE	DESCRIPTION	TIP	LENGTH
67-1750	Small	4 x 9 mm	6 ¼ in 160 mm

Ball End Elevator



CODE	DESCRIPTION	LENGTH
66-5490	Cur ved	7 ½ in 190 mm

Austin Elevator



CODE	DESCRIPTION	TIP	LENGTH
61-0302	Knife Elevator, Angled 90°	2 mm Round	6 ¼ in 160 mm

Elevators (Middle Ear)



Guilford-Wright Drum Elevator

CODE	DESCRIPTION	TIP WIDTH	LENGTH
61-0323	Elevator	2 mm	5 ½ in140 mm

Paparella Drum Elevator

Double - Ended

CODE	DESCRIPTION	LENGTH
61-37 10	Elevator Knife, #3	7 ¼ in185 mm



House Bayonet Elevator & Chisel

CODE	DESCRIPTION	TIP WIDTH	LENGTH
61-0394	Cur ved	1 mm	6 ¾ in170 mm

Elevators (Middle Ear)

Paparella Duckbill Elevator

CODE	DESCRIPTION
61-0440	3.5 mm Curved Blade



LENGTH
6 ½ in 165 mm

House "Gimmick" Elevator

CODE	DESCRIPTION	TIP	LENGTH
61-0376	15° Angle	1 x 12 mm	6 ½ in 165 mm

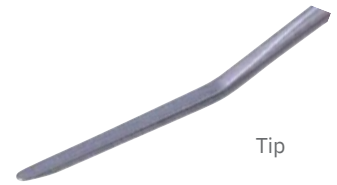

Hough "Hoe" Elevator

CODE	DESCRIPTION	TIP	LENGTH
61-0340	Angled Shaft , 90° Tip Angle	0.5 mm	6 in 150 mm



Austin Duckbill Knife Elevator

CODE	DESCRIPTION	TIP
61-0301	Curved Tip	2 x 8 mm



LENGTH
6 ¼ in 160 mm

Elevators (Middle Ear, Nasal)

Tabb Elevator

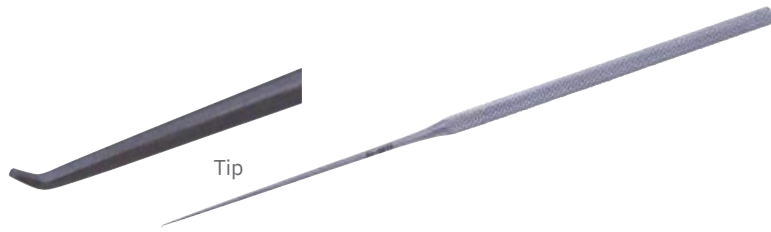

CODE	DESCRIPTION	BLADE	LENGTH
61-0272	45° Angle	1 mm	6 ½ in 165 mm

Elevators (Middle Ear, Nasal)

Boies Nasal Fracture Elevator

CODE	DESCRIPTION	TIP WIDTH	LENGTH
67-1570	Heavy Shaft, Blunt Edges	9 mm	7 ¾ in 195 mm



55-7026

Freer Elevator

CODE	DESCRIPTION	TIP	LENGTH
55-7026	4.5 mm, Double-Ended	1 mm	7 ½ in 190 mm
55-7027	6.5 mm, Double-Ended	1 mm	7 in 190 mm



Elevators (Periosteal, Septal, Skin)

Dingman Periosteal Elevator

CODE	DESCRIPTION	LENGTH
68-0905	Double - Ended	7 ¼ in 185 mm



Elevators (Periosteal, Septal, Skin)



26-4224

McKenty Periosteal Elevator

CODE	DESCRIPTION	TIP	LENGTH
26 - 42	Light Curve	4 mm	6 in 150 mm
24 26-4225	Light Curve	Wide 5 mm Wide	6 in 150 mm

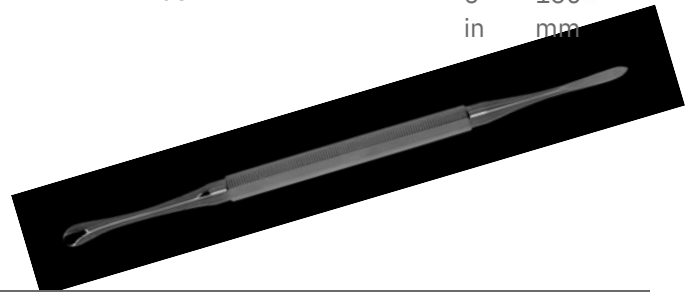

Molt Periosteal Elevator

CODE	DESCRIPTION	LENGTH
26	Sharp/Blunt, Double-Ended	7 1/8 in 180 mm
-3703	Sharp/Sharp, Double-Ended	7 in 180 mm
26-3707		1/8 in 180 mm



67-1891

Obwegeser Periosteal Elevator

CODE	DESCRIPTION	TIP	LENGTH
67-1890	Elevator	7 mm Wide	7 in 175 mm
67-1891	Elevator	11 mm Wide	7 in 175 mm

Seldin Periosteal Elevator

CODE	DESCRIPTION	LENGTH
68-0393	#23, Flat Handle	7 3/4 in 197 mm

Elevators (Septal)

Cottle Septum Elevator



CODE	DESCRIPTION	LENGTH
67-1623	Double-Ended with Graduations	8 ¾ in 220 mm

Goldman Septum Elevator



67-1575

CODE	DESCRIPTION	LENGTH
67-1575	Heavy Tapered Blade	7 ½ in 190 mm

Tebbets Septal Elevator



CODE	DESCRIPTION	LENGTH
67-1770	Elevator	8 ¾ in 210 mm

Elevators (Skin)

Cottle Skin Elevator



67-1550

CODE	DESCRIPTION	LENGTH
67-1551	Blunt	7 ½ 190
67-1550	Sharp	in 7 mm
		½ in 190
		mm

Elevators (Zygoma)

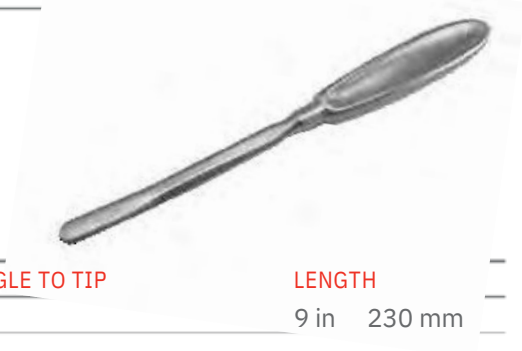

Gillies Zygoma Elevator

CODE	TIP WIDTH	FROM ANGLE TO TIP	LENGTH
68-4510	9 mm	35 mm	9 in 230 mm

Alderdyce Elevator

CODE	DESCRIPTION	WIDTH	LENGTH
72-2530	Double-Ended, Sharp/Blunt	8 mm	8 ½ in 215 mm

Dingman Elevator

CODE	DESCRIPTION	LENGTH
68-0920	Cur ved	8 ¼ in 210 mm

Exodontia Elevator

CODE	DESCRIPTION	LENGTH
68-0298	#34S	6 in 150 mm

Elevators (Zygoma)

Hajek Ballenger Elevator

Double - Ended

CODE	DESCRIPTION	TIP	LENGTH
66-5430	Blunt, Semi-Sharp, Heavy	5 mm	7 ¾ in 197 mm



Tip

Lempert Elevator

CODE	DESCRIPTION	TIP	LENGTH
61- 0 514	Solid Handle, Curved Tip	7 mm	7 ¾ in 185 mm



63-0401

Lempert Elevator

CODE	DESCRIPTION	TIP	LENGTH
63-0401	Small with Slight	2	6 ¾ 170
63-0402	Curve Small with	mm	in 6 mm
	Slight Curve	3	¾ in 170
		mm	mm

McCulloch Elevator

CODE	DESCRIPTION	TIP	LENGTH
66-6500	Semi-sharp	3 mm	7 ½ in 190 mm



Elevators (Zygoma)



Pennington Elevator

CODE	DESCRIPTION	TIPS	LENGTH
66-5450	Double - Ended	6 x 9 mm and 6 x 11 mm	8 ½ in 215 mm



Pierce Elevator

CODE	DESCRIPTION	LENGTH
66-5455	Double-Ended, Right and Left Blade	7 ½ in 190 mm

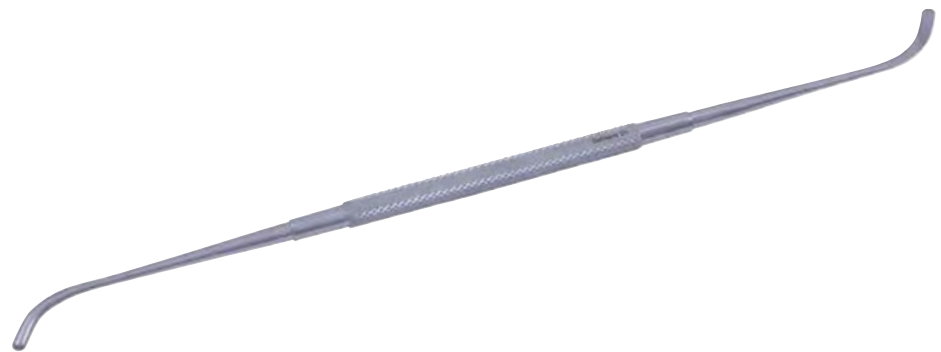

Rogers Elevator

CODE	DESCRIPTION	LENGTH
66-5500	Curved, Double-Ended, Semi-Sharp Blades	8 ¼ in 210 mm

Energy (Bayonet Monopolar Forceps)

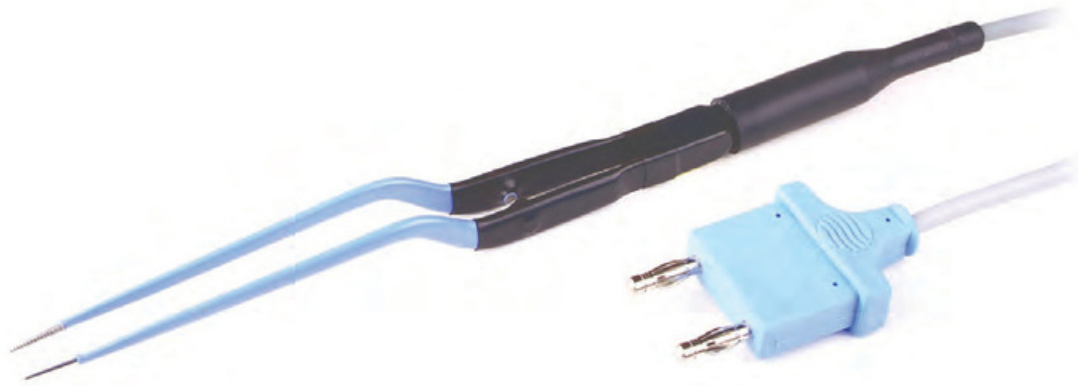

Bayonet Monopolar Forceps, Hand-Controlled

Reusable, Serrated Tips, Insulated with 10 ft (3.0 m) Attached Cord, 1 Each

Length (L)	6 1/2 in 165 mm	8 1/4 in 210 mm	7 1/2 in 191 mm	7 1/2 in 191 mm
Working (WL)	3 1/4 in 83 mm	7 1/2 in 191 mm	3 3/4 in 95 mm	3 3/4 in 95 mm

TIP SIZE	SERRATED TIP	SERRATED TIP	STRAIGHT	CATHEDRAL
0.5 mm	11104	1160	1120	112 13
1.0 mm	11102	5	6	112 12
1.5 mm	11101	1160	1120	112 10
2.0 mm	11100	4	5	11208
		1160	1120	
		2	4	
		1160	1120	

Energy (Reusable Bipolar Forceps)



10-1445I

Bayonet Bipolar Forceps, Angled Up

Reusable, Smooth Tips, 1 Each

Length (L)	8 1/4 in 210 mm	10 1/2 in 267 mm	8 1/4 in 210 mm	10 1/2 in 267 mm
Working (WL)	4 1/4 in 108 mm	6 1/4 in 159 mm	4 1/4 in 108 mm	6 1/4 in 159 mm

TIP SIZE	NON-INSULATED	NON-INSULATED	INSULATED	INSULATED
1.0 mm	10 -14	10 -14	10-1445I	10-1482I
1.5 mm	-14 47	-14 8 6	10-1447I	10-1486I
2.0 mm	49	8 8	10-1449I	10-1488I

Energy (Reusable Bipolar Forceps)

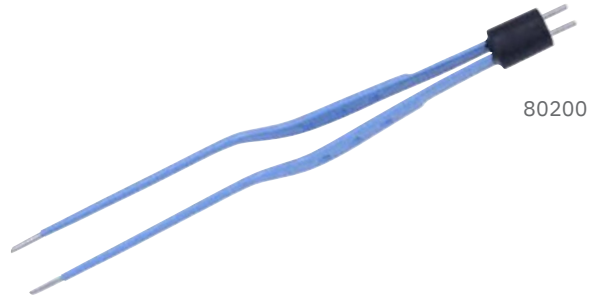

80200

Bayonet Bipolar Forceps, Insulated

Reusable Smooth Tip, Sold Individually

Length (L)	6 1/4 in 165 mm	7 1/2 in 190 mm	7 3/4 in 197 mm	8 5/8 in 219 mm	12 in 305 mm
Working (WL)	2 3/4 in 70 mm	3 in 76 mm	3 5/8 in 92 mm	4 1/2 in 114 mm	7 7/8 in 200 mm

TIP SIZE	INSULATED	INSULATED	INSULATED	INSULATED	INSULATED
micro	80205	80304			
0.5 mm	80204	80303	80434	8057	
0.75 mm			80433	4	
1.0 mm	80202	80302		8057	80582
1.2 mm			80432	80572	
1.5 mm	80201	80301	80431	80571	80581
2.0 mm	80200	80300	80430	80570	80580
mm					



10-1372I

Bayonet Bipolar Forceps, Insulated

Reusable Smooth Tip, Sold Individually

Length (L)	6 3/4 in 159 mm	7 7/8 in 181 mm	8 3/4 in 210 mm	10 1/2 in 267 mm
Working (WL)	2 3/4 in 70 mm	2 3/4 in 70 mm	4 1/2 in 108 mm	6 3/4 in 159 mm

TIP SIZE	INSULATED	INSULATED	INSULATED	INSULATED
0.5 mm	10 -1311I	10 -1360I	10 -14 2 1I	10-
0.75 mm	10 -13 2 1I	10 -1361I	10-1401I	1483I
1.0 mm	10 -13 2 2I	10 -1362I	10-1431I	10-
1.5 mm	10 -13 3 1I	10 -137 1I	10-1411I	1485I
2.0 mm		10 -1372I	10-1412I	10-
mm				1481I
				10-
				1484I

EAR, NOSE & THROAT

Energy (Reusable Bipolar Forceps)

Gerald Bipolar Forceps

Reusable, Smooth Tips, 1 Each

CODE	DESCRIPTION	TIP SIZE	LENGTH
10 -1180I	Forceps, Insulated	1.0 mm	7 1/4in 184 mm



Cushing Bayonet Bipolar Forceps

Reusable, 1 Each

CODE	DESCRIPTION	TIP SIZE	LENGTH
08-0000I	Forceps,	0.7 mm	7 1/2 191
08-0026I	Insulated	1.0 mm	2in 7 mm
08-0027I	Forceps,	1.5 mm	1 1/2in 191
	Insulated		7 1/2 mm
	Forceps,		2in 191
	Insulated		mm



08-0000

Cushing Bipolar Forceps

Reusable, Smooth Tips, 1 Each

CODE	DESCRIPTION	TIP SIZE	LENGTH
10 -1160I	Forceps,	1.0	7 178
10 -1162I	Insulated	mm	in mm
	Forceps,	1.5	7 178
	Insulated	mm	in mm

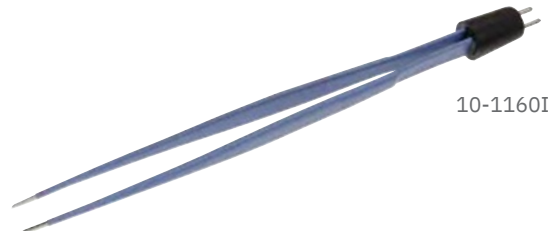

10-1160I

Energy (Reusable Bayonet Forceps)



90-7004

Bayonet Bipolar Forceps, Midas Touch® Non-Stick

Reusable Smooth Tip, Insulated

Length (L)	7 ¾ in 197 mm	8 ⅝ in 219 mm	10 ½ in 267 mm
Working (WL)	3 ⅝ in 92 mm	4 ⅜ in 111 mm	6 ¼ in 159 mm

TIP SIZE	INSULATED	INSULATED	INSULATED
0.5 mm	90-7004	90-8012	90-9008
0.75 mm	90-7000	90-8000	90-9007
1.2 mm	90-7005	90-8013	90-9006
1.5 mm	90-7001	90-8001	90-9005
2.0 mm	90-7006	90-8003	90-9009



90-8007

K-Style Standard Angle Bayonet Bipolar Forceps, Curved Up

Reusable, Smooth Tip, Midas Touch Non-Stick Tips, 1 Each

Length (L)	8 ⅝ in 219 mm	9 ¼ in 229 mm	Length (L)	8 ⅝ in 219 mm	9 ¼ in 229 mm
Working (WL)	4 ¼ in 114 mm	5 ¼ in 130 mm	Working (WL)	4 ¼ in 114 mm	5 ¼ in 130 mm

TIP SIZE	INSULATED	INSULATED	TIP SIZE	INSULATED	INSULATED
0.5 mm	90-8017	90-9509	0.5 mm		
0.75 mm	90-8018	90-9510	0.75 mm		
1.0 mm	90-8007	90-9502	1.0 mm	90-8009	90-9505



90-8006

K-Style Standard Angle Bayonet Bipolar Forceps, Straight

Reusable, Smooth Tip, Midas Touch Non-Stick Tips, 1 Each

Length (L)	8 ⅝ in 219 mm	9 ¼ in 229 mm	10 ½ in 267 mm
Working (WL)	4 ¼ in 114 mm	5 ⅞ in 130 mm	6 ¼ in 159 mm

TIP SIZE	INSULATED	INSULATED	INSULATED
0.5 mm	90-8015 90-8016	90-9507 90-	
0.75 mm	90-8006, 90-8008	9508 90-9501,	
1.0 mm		90-9504 90-9500	90-9001
1.5 mm			90-9000

EAR, NOSE & THROAT

Energy (Reusable Bipolar Forceps)

Potts-Smith Bipolar Forceps

Reusable, Smooth Tips, 1 Each

CODE	DESCRIPTION	TIP SIZE	LENGTH
80404	Forceps,	Micro	7 1/2 184
80403	Insulated	0.5	4in 7 mm
80402	Forceps,	mm	1/2 184
80401	Insulated	1.0	4in 7 mm
80400	Forceps,	mm	1/2 184
	Insulated	1.5	4in 7 mm
	Forceps,	mm	1/2 184
	Insulated	2.0	4in 7 mm
	Forceps,	mm	1/2 184
	Insulated		4in mm

Scoville-Greenwood Bayonet Bipolar Forceps

Reusable, 1 Each

CODE	DESCRIPTION	TIP SIZE	LENGTH
08-0030	Forceps, Non-	1.5 mm	7 1/2in 191
08-0092	Insulated Forceps,	1.5 mm	7 in mm
08-0028I	Non-Insulated	0.25	7 3/4in 178
08-0030I	Forceps, Insulated	mm 1.5	7 1/2in mm
	Forceps, Insulated	mm	197

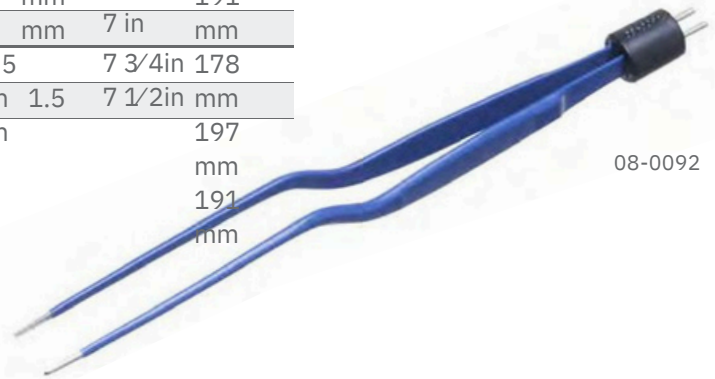

Semkin Bipolar Forceps

Reusable, Smooth Tips, 1 Each

CODE	DESCRIPTION	TIP SIZE	LENGTH
10 -1091I	Forceps, Insulated Forceps, Insulated	0.75mm	5 1/2in 140
10 -1191I	Midas Touch Non-Stick, Insulated	0.75mm	5 1/2in mm
90-3000			5 3/4in 140



Energy (Single-Use Bipolar Forceps)

Adson Bipolar Forceps, Smooth Tip

10 per Box

CODE	DESCRIPTION	TIP SIZE	LENGTH	
20 -1082I	Forceps, Insulated	1.0	5	127
20 -1082KI	Kit, Insulated	mm	in	mm
		1.0	5	127
		mm	in	mm



90-3000

Single-Use Bayonet Bipolar Forceps, Acute Angle

Smooth Tips, 10 per Box

Length (L)	7 ½ in 191 mm	7 ½ in 191 mm
Working (WL)	4 ⅞ in 105 mm	4 ⅞ in 105 mm

TIP SIZE	FORCEPS, INSULATED	KIT, INSULATED
0.75	20-	20-1530KI
mm 1.0	1530I	
mm 1.5	20-	20-1550KI
mm	1540I	
	20-	
	1550I	

Single-Use Bayonet Bipolar Forceps, Acute Angle

Smooth Tips, 10 per Box

Length (L)	8 3/8in 213 mm	8 3/8in 213 mm	8 3/8in 213 mm	8 3/8in 21.3 mm
Working (WL)	5 1/8in 130 mm	5 1/8in 130 mm	5 1/8in 130 mm	5 1/8in 130 mm

TIP SIZE	FORCEPS, NON-INSULATED	FORCEPS, INSULATED	KIT, NON-INSULATED	KIT, INSULATED
0.75				20 -1560KI
mm 1.0	20 -1570	20 -1570I	20 -1570 K	20 -1570 KI
mm 1.5	20-1580		20-1580K	
mm				

Energy (Single-Use Bipolar Forceps)



20-1482I

Single-Use Bayonet Bipolar Forceps, with Midas Touch® Non-Stick Tips

5 per Box

Length (L)	6 1/4in 159 mm	7 1/2in 191 mm
Working (WL)	3 3/4in 95 mm	3 in 70 mm

TIP SIZE	INSULATED	INSULATED
0.5 mm	20 -1315IMT	20 -13
0.75 mm	20 -1320IMT	86IMT 20-
1.0 mm	20 -132 5IMT	1384IMT
1.5 mm	20 -13 30IMT	20 -13
		82IMT 20
		-13 80IMT



20-1482I

Single-Use Bayonet Bipolar Forceps, Angled Up

Smooth Tips, 10 per Box

Length (L)	10 1/2in 267 mm	10 1/2in 267 mm
Working (WL)	6 in 152 mm	6 in 152 mm

TIP SIZE	FORCEPS, INSULATED	KIT, INSULATED
1.0 mm	20 -1682I	20-1682KI-28



20-1320

Single-Use Bayonet Bipolar Forceps

Smooth Tips, 10 per Box

Length (L)	6 1/4in 159 mm	6 1/4in 159 mm	6 1/4in 159 mm
Working (WL)	3 3/4in 95 mm	3 3/4in 95 mm	3 3/4in 95 mm

TIP SIZE	FORCEPS, INSULATED	KIT, NON-INSULATED	KIT, INSULATED
0.5 mm	20 -1315I	20 -1315K	20 -1315KI
0.75 mm	20 -1320I	20 -1320K	20 -13 20 KI
1.0 mm	20 -13 2 5I	20-1325K	20-1325KI
1.5 mm	20-1330I	20-1330K	20 -13 3 0 KI

Energy (Single-Use Bipolar Forceps)

Single-Use Bayonet Bipolar Forceps



20-1370

Smooth Tips, 10 per Box

Length (L)	7 1/8in 181 mm	7 1/8in 181 mm
Working (WL)	2 3/4in 70 mm	2 3/4in 70 mm

TIP SIZE	FORCEPS, INSULATED	KIT, INSULATED
0.5 mm	20-1355I	20-1355KI
0.75	20 -1360I	20 -1360KI
mm 1.0	20 -1340I	20-1340KI
mm 1.5	20 -1370I	20 -1370 KI
mm 2.0	20 -137 5I	20-1375KI
mm		

Single-Use Bayonet Bipolar Forceps



20-1380I

Smooth Tips, 10 per Box

Length (L)	7 1/2in 191 mm	7 1/2in 191 mm
Working (WL)	3 in 76 mm	3 in 76 mm

TIP SIZE	FORCEPS, INSULATED	KIT, INSULATED
0.5 mm	20-	
0.75	1386I	
mm 1.0	20-	20-1382KI
mm 1.5	1384I	20 -13 8 0 KI
mm	20-	
	1382I	
	20-	
	1380I	

Single-Use Bayonet Tonsil Bipolar Forceps

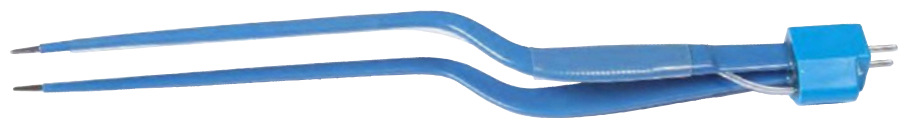

Smooth Tips, Angled Down, Insulated, 10 per Box

Length (L)	7 1/2in 191 mm	7 1/2 in 191 mm
Working(WL)	3 in 76 mm	3 in 7.6 mm

TIP SIZE	FORCEPS, INSULATED	KIT, INSULATED
1.5 mm	20-1381I	20-1381KI-28

Energy (Single-Use Bipolar Forceps)

Single-Use Gerald Bipolar Forceps

Smooth Tips, 10 per Box

CODE	DESCRIPTION	TIP SIZE	LENGTH
20 -118 0	Forceps, Non-Insulated	1.0	7 1/4 184
20 -1180I	Forceps, Insulated	mm	4in 7 mm
20-1180K	Kit, Non-Insulated	1.0	1/ 184
20 -118 0 K	Kit, Insulated	mm	4in 7 mm
		1.0	1/ 184
		mm	4in 7 mm
		1.0	1/ 184
		mm	4in mm



20-1180

Single-Use Semkin Bipolar Forceps

Smooth Tips, 10 per Box

CODE	DESCRIPTION	TIP SIZE	LENGTH
20 -109 0I	Forceps,	0.75 mm	5 3/4in 146
20-1190I	Insulated	1.0 mm	5 1/2in mm
20-1090KI	Forceps,	0.75 mm	5 3/4in 140
20-1190KI	Insulated Kit,	1.0 mm	5 1/2in mm
	Insulated Kit,		146
	Insulated		mm
			140
			mm



20-1090

Single-Use Semkin Bipolar Forceps

Midas Touch® Non-Stick, 5 per Box

CODE	DESCRIPTION	TIP SIZE	LENGTH
20 -1090IMT	Forceps, Insulated	0.75 mm	5 3/4in 146 mm



Excavators (Middle Ear)

House "Hoe" Excavator



CODE	DESCRIPTION	TIP	LENGTH
61-0363	Straight Shaft, Angled 90°	0.5 mm	6 ½ in 165 mm



Austin Excavator

CODE	DESCRIPTION	TIP	LENGTH
61-0303	Angled Right	0.75 mm	6 ¼ 160 in 6 mm
61-0304	Angled Left	0.75 mm	¼ in 160 mm

Foot Plate Hooks (Middle Ear)

Austin Foot Plate Hook

CODE	DESCRIPTION	TIP WIDTH	LENGTH
61-0319	Angled 90°	0.33 mm	6 ¼ 160 in 6 mm
61-0321	Angled 90°	0.50 mm	¼ in 160 mm

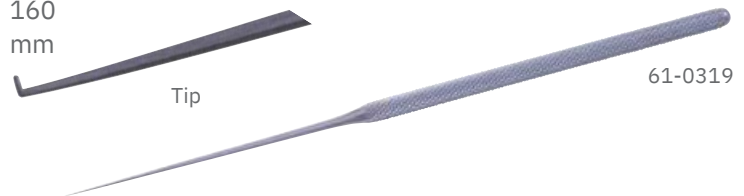

Forceps (Alligator)

Bellucci Alligator Forceps

Finely Serrated, 8 mm Jaw

CODE	DESCRIPTION	LENGTH
61- 0132	75 mm Shaft	5 ¼ in 135 mm



Goodhill Alligator Forceps

CODE	DESCRIPTION	LENGTH
61- 0136	75 mm Shaft	5 ¼ in 135 mm



Hartmann Alligator Forceps

CODE	DESCRIPTION	LENGTH
61- 0127	Serrated Extra Delicate	3 ½ in 90 mm

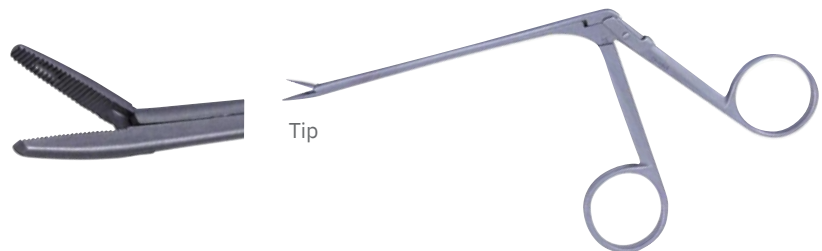

Forceps (Biopsy)

Biopsy Forceps

Double-Action, 2 x 3 Cups, 9 mm Shaft

CODE	SHAFT	LENGTH
6 3 - 5703	Straight	6 ¼ 160
6 3 - 5701	Curved Up 70°	in 6 mm
6 3 - 5702	Curved Up 110°	¼ in 160
		6 ¼ mm
		in 160
		mm

Forceps (Biopsy)

Punch Biopsy Forceps

Single Action Thru-Biting, 1.5 x 3 mm Bite

CODE	DESCRIPTION	LENGTH
63-	Straight	7 ¼ 185
5706 6	70° Long Curve	in 7 mm
3 - 5704	70° Short Curve	¼ in 185
63-		7 ¼ mm
5705		in 185 mm



Roberts Biopsy Forceps

CODE	DESCRIPTION	WORKING LENGTH
74-5936	6 mm Cup	16 in 400 mm

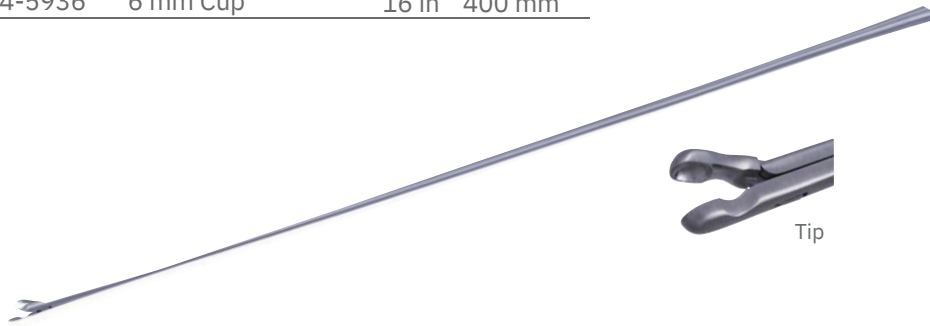

Forceps (Biting)

Cottle-Kazanjian Cutting Forceps

Angled

CODE	BLADE	LENGTH
3 3 - 0418	29 mm	7 ½ in 180 mm



Forceps (Crimper)

Juers Crimper Forceps

75 mm Shaft, Delicate 6 mm Jaws

CODE	JAWS	LENGTH
61- 013	Bayonet Left	5 ¼ in135 mm
3 61-	Bayonet Right	5 ¼ in135 mm
0134		

Scheer Crimper Forceps

Single Lengthwise Groove in Lower Jaw, 75 mm Shaft

CODE	JAWS	LENGTH
61- 0145	5 mm, Smooth	5 ¼ in135 mm



Forceps (Cutting)

Kleinsasser Cutting Forceps

Heavy Model

CODE	JAWS	WORKING LENGTH	LENGTH
74-6047	2.5 mm Diameter, 5 mm Cup	9 in230 mm	5 ¼ in135 mm

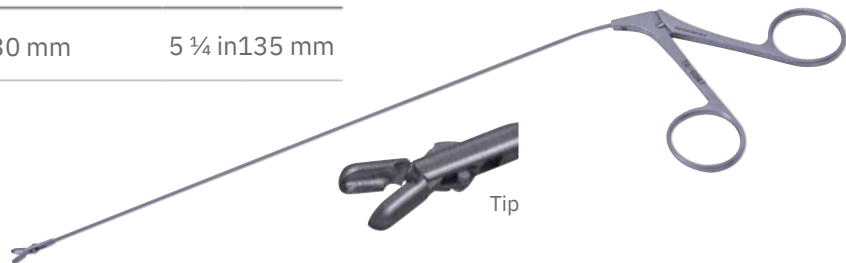

Forceps (Double-Spoon)

Double-Spoon Forceps

CODE	DESCRIPTION
66-2599	Pear Jaws, 100°



Forceps (Double Spoon)

Giraffe Polyp Forceps

CODE	DESCRIPTION
63-0569	Pear-Shaped, 80°

Forceps (Dressing)

Wilde Dressing Forceps

CODE	DESCRIPTION	LENGTH
61- 0108	Serrated Tip, Delicate Pattern	5 ¾ in 145 mm



Forceps (Ear)

Hartmann Ear Forceps

CODE	DESCRIPTION	JAWS	LENGTH
61- 0111	Delicate	3 x 6 mm	5 ½ in 140 mm

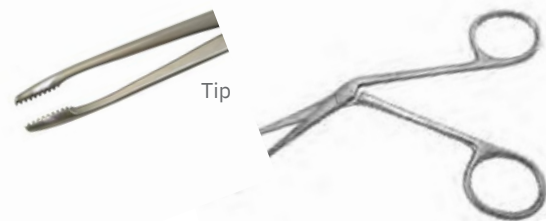

Hartman-Herzfeld Forceps

CODE	DESCRIPTION	LENGTH
61- 012 1	2 mm Cup, Straight 6 mm Jaws on 71 mm Shaft	5 ¾ in 135 mm
61- 012 2	3 mm Cup, Straight 6 mm Jaws on 71 mm Shaft	5 ¾ in 135 mm
61- 012 3	2 mm Cup, Up Biting on 71 mm Shaft	5 ¾ in 135 mm



Forceps (Ear)

Hartmann-Herzfeld Ear Forceps

2 mm Cup, Up Biting, 6 mm

CODE	DESCRIPTION	LENGTH
61-0123	71 mm Shaft	5 ¼ 135
61-0123E	Ebonized	in 5 mm
		¼ in 135 mm

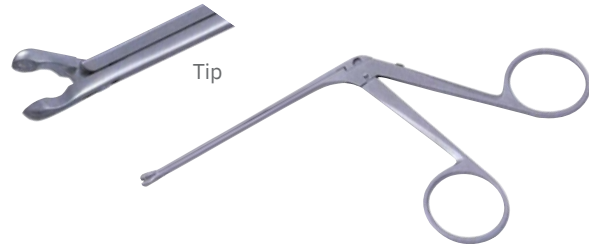

Hartmann Ear Forceps

Angular, Serrated

CODE	TIP SIZE	LENGTH
30-6951	10 in 7.6 mm	3 ½ in 89 mm

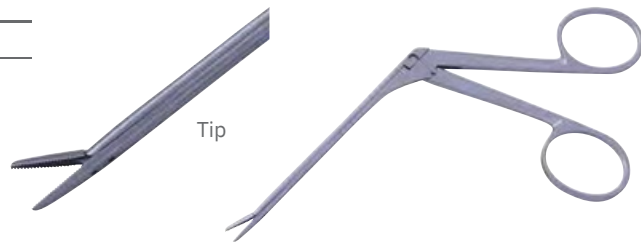

Lucae Bayonet Dressing Forceps

CODE	DESCRIPTION	LENGTH
07-3074	Serrated, Delicate	5 ¾ in 145 mm

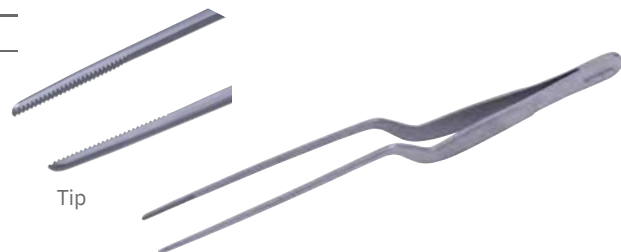

Lucae Ear Forceps

Bayonet Shape

CODE	WORKING DISTANCE	TIP WIDTH	LENGTH
30-68982	¾ in 70 mm	2 mm	5 ½ in 140 mm

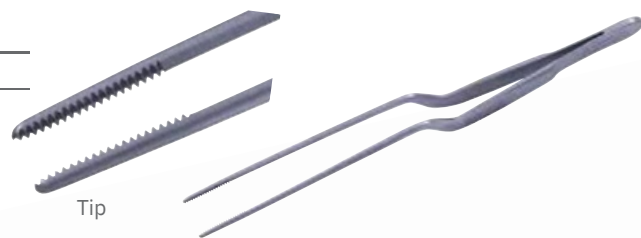

Noyes Ear Forceps

77 mm Shaft

CODE	JAWS	LENGTH
61-0116	Regular, 6 mm, Serrated	5 ½ 140 mm
61-0118	Flat, 8 mm, Serrated	in 5 135 mm
		¼ in



61-0116

Forceps (Ear)

Struempel Ear Forceps

75 mm Shaft, Fenestrated Oval Spoon

CODE	JAWS	LENGTH
61- 0120	2.5 x 6 mm	5 ½ in 140 mm



Tobey Ear Forceps

Very Delicate

CODE	JAWS	LENGTH
61- 0113	2 x 4 mm, Serrated	5 ½ in 140 mm



Weingartner Ear Forceps

75 mm Shaft

CODE	JAWS	LENGTH
61- 0119	3 x 7 mm, Serrated	5 ¼ in 135 mm

Forceps (Ear Micro)

Micro Alligator Forceps

Straight

CODE	JAWS	LENGTH
58-46303	mm	7 ¼ in 185 mm



Forceps (Frontal Sinus)

Frontal Sinus Giraffe Forceps

Double Action Cupped Forceps

CODE	DESCRIPTION	ANGLES	LENGTH
63-8845	2 mm	45° Horizontal	5 ¼ 135
63-8865	Jaws 2	90° Horizontal	in 5 mm
63-8870	mm Jaws	90° Vertical	¼ in 135
63-8855	2 mm	45° Horizontal	5 ¼ mm
63-8850	Jaws 3	45° Vertical	in 5 135
63-8875	mm Jaws	90° Horizontal	¼ in mm
63-8880	3 mm	90° Vertical	5 ¼ 135
	Jaws 3		in 5 mm
	mm Jaws		¼ in 135
	3 mm		5 ¼ mm
	Jaws		in 135
			mm
			135
			mm



63-8845

Forceps (Laryngeal)

Jackson Laryngeal Forceps

CODE	DESCRIPTION	LENGTH
74-5757	Angled Up, 4 mm Cup	8 in 200 mm



Tip

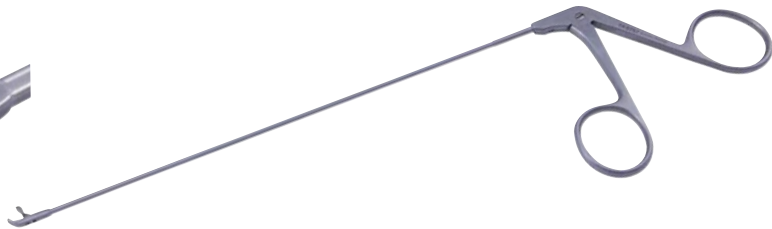

Jackson Laryngeal Forceps Alligator Forceps

Standard Jaws, Deep Serrations and Grooves

CODE	JAWS	WORKING LENGTH
74-5800	4 x 22	280
74-5801	mm 4 x	mm
	22 mm	350
		mm



Tip



Forceps (Cup)

Jackson Laryngeal Forceps Cup Forceps

Angled Up

CODE	DESCRIPTION	CUP SIZE	WORKING LENGTH
74-	Extra Lightweight Construction	2 mm 2	280 mm 280 mm
5718	Extra Lightweight Construction	mm 4	280 mm 200 mm
74-	Standard Standard	mm 6	
5717		mm	

74-
5706
74-
5710



Tip



74-5706

Jackson Laryngeal Forceps Cup Forceps

Straight

CODE	DESCRIPTION	CUP SIZE	WORKING LENGTH
74-	Extra Lightweight Construction	2 mm 2	200 mm 280 mm
5715	Extra Lightweight Construction	mm 4	280 mm 280 mm
74-	Standard Standard	mm 6	
5716		mm	

74-
5700
74-
5708



Tip

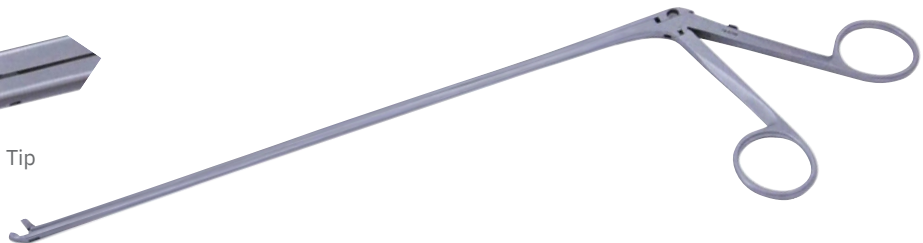

Forceps (Maxillary)

Rowe Maxillary Disimpaction Forceps

CODE	DESCRIPTION	LENGTH
68-5001	Left	9 ½ in 240 mm
68-5002	Right	9 ½ in 240 mm



68-5002

Forceps (Cup)

Jako Micro Laryngeal Cup Forceps

CODE	DESCRIPTION	ROUND CUPS	LENGTH
74-	Straight	2	9 ¼ in 235 mm
5925	Curved Left	mm	9 ¼ in 235 mm
74-	Curved Right	2	9 ¼ in 235 mm
5926	Curved Up	mm	9 ¼ in 235 mm
74-		2	
5927		mm	
74-		2	
5928		mm	



74-5926

Forceps (Micro Laryngeal Cup)

Jako-Kleinsasser Micro Laryngeal Cup Forceps

Extremely Delicate

CODE	DESCRIPTION	CUPS	LENGTH
74-	Straight	1	8 ⅝ in 220 mm
5960	Angled Left	mm	8 ⅝ in 220 mm
74-	Angled Right	1	8 ⅝ in 220 mm
5964	Angled Up	mm	8 ⅝ in 220 mm
74-		1	
5962		mm	

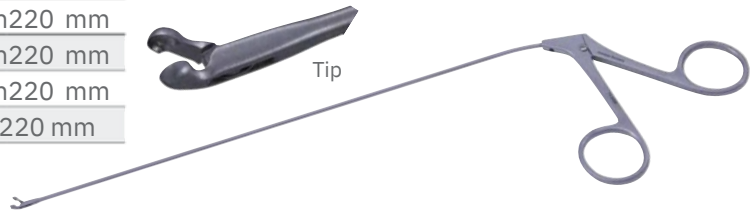

Kleinsasser Micro Laryngeal Cup Forceps

CODE	DESCRIPTION	CUPS	LENGTH
74-6019	Straight	1 mm	10 ¾ in 270 mm
74-6020	Straight	2 mm	10 ¾ in 270 mm
74-6024	Curved Left	1 mm	10 ¾ in 270 mm

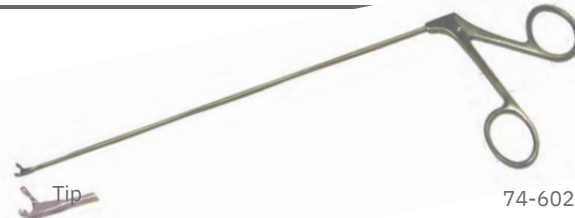

74-6024

Forceps (Micro Laryngeal Grasping)

Jako-Kleinsasser Micro Laryngeal Grasping Forceps

CODE	DESCRIPTION	LENGTH
74-5972	Straight	8 ⅝ in 220 mm
74-5971	Curved Right	8 ⅝ in 220 mm

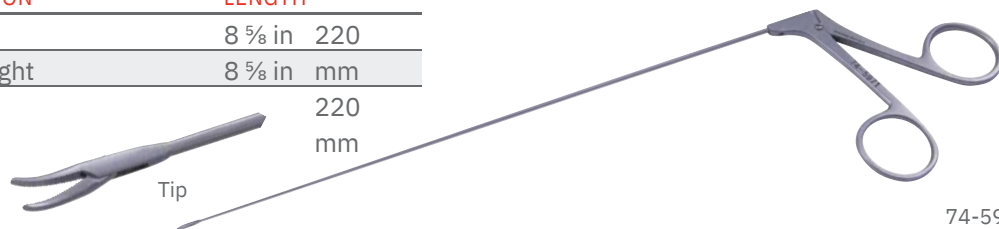

74-5971

Forceps (Laryngeal)

Jako Micro Laryngeal Instruments Alligator Grasping Forceps

Serrated Jaws

CODE	DESCRIPTION	JAWS	LENGTH
74-	Straight	1.5 x 10 mm	9 ½ in 240 mm
5920	Curved Left	1.5 x 8.5 mm	9 ½ in 240 mm
74-	Curved Right	1.5 x 8.5 mm	9 ½ in 240 mm
5921	Curved Up	1.5 x 8.5 mm	9 ½ in 240 mm

74-
5922
74-
5923

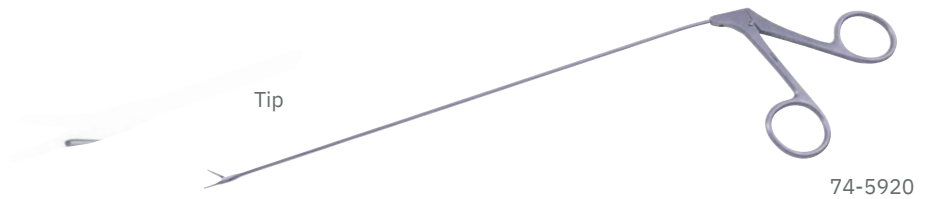

Forceps (Middle Ear)

House Miniature Forceps

3 mm, Finely Serrated

CODE	DESCRIPTION	LENGTH
61- 0160	73 mm Shaft	5 ¼ in 135 mm



Ebonized House-Wullstein Miniature Forceps

3 mm, Finely Serrated

CODE	DESCRIPTION	LENGTH
61-0160E	75 mm Shaft	5 ¼ in 135 mm



Forceps (Middle Ear)

House Oval Cup Forceps

DESCRIPTION	CUPS	LENGTH
61-0152, 61-0154 Straight, 75 mm Shaft	0.6 x 1.0 mm Oval	5 ¼ 135
61-0155, 61-0142 Angled Left 15°, 75 mm Shaft	0.6 x 1.0 mm Oval	in 5 mm
61-0143 Angled Right, 75 mm Shaft	0.6 x 1.0 mm Oval	¼ in 135
61-0155E Angled Right 15°, 0.9 mm	Oval	5 ¼ mm
Ebonized Angled Left 15°, 0.9 mm	Oval	in 5 135
		¼ in mm
		5 ¼ 135
		in 5 mm
		¼ in 135
		mm
		135

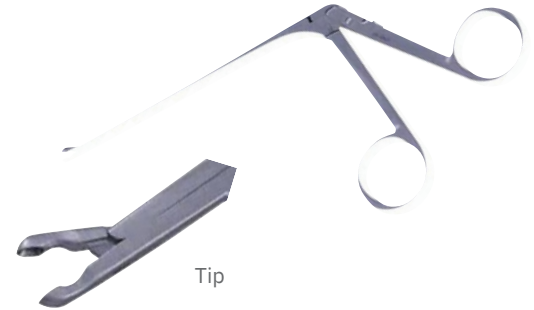

House Miniature Forceps

4.0 mm, Finely Serrated

CODE	DESCRIPTION	LENGTH
61-014773	73 mm Shaft	5 ¼ 135
61-0147E75	75 mm Shaft, Ebonized	in 5 mm
		¼ in 135
		mm



61-0147

House Wullstein Miniature Ear Cup Forceps

Very Fine Oval Cup

CODE	DESCRIPTION	CUP SIZE	LENGTH
61-4122	61-4122 Straight, 75 mm Shaft	0.6 x 1 mm 0.6	5 125
61-0170	61-0170 Angled Up, 72 mm Shaft	Angled Up 90°, 72 mm	in mm
61-1290	61-1290 Angled Down, 72 mm Shaft	Angled Down, 72 mm	5 125
61-1287	61-1287 Angled Up 35°, 72 mm Shaft		in mm
61-1288			5 125
			in mm
			5 125
			in mm



61-0170

House Alligator Crimper Forceps

Serrated

CODE	DESCRIPTION	JAWS	LENGTH
61-013875	75 mm Shaft	8 mm Tapered to Dull Point	8 5/8 in 220 mm



Forceps (Middle Ear)

House Alligator Forceps

Serrated

CODE	DESCRIPTION	SHAFT	JAWS	LENGTH
61- 014	Straight	74	6	5 ½ 140 mm
6 61- 014 0	Right Side Opening	mm	mm	in 5 135 mm
		75	6	¼ in
		mm	mm	



61-0146

Hough CRURA Stapedectomy Forceps

3 mm Blade, Smooth 5 mm Jaws, Shaft 75 mm

CODE	DESCRIPTION	LENGTH
61-	Angled 45°, Left	9 ½ in 240 mm
0130	Angled 45°,	9 ½ in 240 mm
61- 012	Right Angled	9 ½ in 240 mm
9 61- 0126	45°, Right	



61-0126

Tip

House Strut Forceps

75 mm Shaft

CODE	JAWS	LENGTH
61- 0139	Smooth 6 mm	5 ¼ in 135 mm



Tip

McGee Wire Crimper Forceps

Delicate 3 mm

CODE	SHAFT	JAWS	LENGTH
61-	72 mm	Angled Down	5 ¼ 135
0124	75 mm	Straight	in 5 mm
61-			¼ in 135
012 5			mm



61-0124

Tip

Forceps (Nasal)

Access Blakesley Forceps

CODE	DESCRIPTION	DIAMETER	WORKING LENGTH
11-	0°	4	89
102	45°	mm	mm
11-	90°	4	89
142		mm	mm
11-		4	89
192		mm	mm



Blakesley Nasal Forceps

CODE	DESCRIPTION	TIP SIZE
66-2551	Straight, Serrated	6 x 13 mm



Noyes Nasal Dressing Forceps

Serrated Jaws, 110 mm Shaft

CODE	JAWS	LENGTH
66-2030	4 x 14 mm	6 ¾ in 171 mm



Takahashi Forceps

CODE	DESCRIPTION	JAWS	LENGTH
63-2026	Straight	2 x 10 mm	6 ¾ in 171 mm

Takahashi Nasal Forceps

4 7/8 in (110 mm) Shaft

CODE	DESCRIPTION	CUP SIZE	LENGTH
63-2019	Upturned 45°	2 x 8 mm	7 ¼ in 185 mm
63-2020	Straight	2.5 x 8	7 ¼ in 185 mm
63-2020S	Straight with Suction	mm	7 ¼ in 185 mm
63-2021	Straight	3 x 10 mm	7 ¼ in 185 mm
		4 x 10 mm	

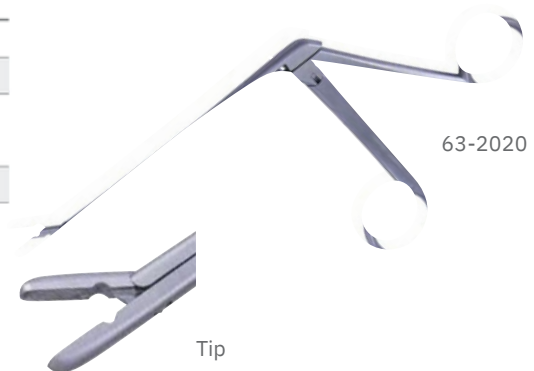

Forceps (Nasal)

Weil-Blakesley Nasal Forceps

Fenestrated Oval Cups, 4 7/16 in (110 mm) Shaft

CODE	SIZE	TIP	LENGTH
66 -2810	#00	2.5 mm, Upturned 45°	7 ½ 190
66 -2811	#0	3.5 mm, Upturned 45°	in 7 mm
63-7634	#0	3.5 mm, Upturned 90°	½ in 190
66 -2812	#1	4 mm, Upturned 45°	7 ½ mm
63-7635	#1	4 mm, Upturned 90°	in 7 190
66 -2813	#2	5 mm, Upturned 45°	½ in mm



Weil-Blakesley Nasal Forceps

Upturned 45°, Fenestrated Oval Cups, 4 7/16 in (110 mm) Shaft, w/Suction

CODE	SIZE	TIP	LENGTH
66	#00	2.5	7 ½ 190
-2810S	#0	mm	in 7 mm
66	#1	3.5 mm	½ in 190
-2811S	#2	4 mm	7 ½ mm
66-		5 mm	in 7 190
2812S			½ in mm
66-			190
2813S			mm



Weil-Blakesley Nasal Forceps

Straight, Fenestrated Oval Cups, 4 3/8 in (110 mm) Shaft

CODE	DESCRIPTION	SIZE	TIP	LENGTH
6 3 -2012		#00	2.5	7 ½ 190
6 3 -20 09		#0	mm	in 7 mm
6 3 -2010		#1	3.5	½ in 190
6 3 -2011		#2	mm 4	7 ½ mm
63-2012S	With Suction	#00	mm 5	in 7 190
63-2009S	With Suction	#0	mm	½ in mm
63-2010S	With Suction	#1	2.5	7 ½ 190
63-2011S	With Suction	#2	mm	in mm
			3.5	7 ½ 190
			mm	in mm
			4 mm	7 ½ 190
			5 mm	in mm
				7 ½ 190
				in



EAR, NOSE & THROAT

Forceps (Nasal)

Weil-Blakesley Nasal Forceps

Fenestrated Oval Cups, 2.5 mm x 4.5 mm cups, 4 3/8 in (11 mm) shaft

CODE	DESCRIPTION	LENGTH
63-7423S	#00 Straight with Suction	7 1/2 190
63-7424S	#00 Upright 45° with Suction	in 7 mm
63-7425S	Suction Upright 90°	1/2 in 190
63-7423	with Suction	7 1/2 mm
63-7425S	#00 Upright 45°	in 7 190
63-7423	#00 Upright 90°	1/2 in mm
6 3 -74		7 1/2 190
24 63-		in 7 mm
7424S		1/2 in 190
		mm
		190
		mm



Weil-Blakesley Thru-Cutting Nasal Forceps

Bottom Jaw Serrated

CODE	DESCRIPTION	JAWS	SHAFT	LENGTH
63-6600	#00 Straight	2.5	120	7 1/4 185
63-6602	#00 Upright 45°	mm	mm	in 7 mm
63-6610	#0 Straight	2.5	120	1/4 in 185
63-6618	#0 Jaws Angled Left	mm	mm	7 1/4 mm
63-6612	#0 Upright 45°	3.5	120	in 7 185
6 3 - 6611	#1 Straight	mm	mm	1/4 in mm
63-6613	#1 Upright 45°	3.5	120	7 1/4 185
		mm	mm	in 7 mm
		3.5	120	1/4 in 185
		mm 4	mm	7 1/4 mm
		mm 4	120	in 185
		mm	mm	Tip mm
			120	185
			mm	mm



66-6612

Forceps (Nasal Dressing)

Hartmann Nasal Dressing Forceps

CODE	DESCRIPTION	LENGTH
6 3 -2017	Nasal Dressing Forceps	7 in 175 mm



Tip



Foreceps (Nasal Polyp)

Watson Williams Nasal Polyp Forceps

CODE	JAWS	SHAFT	LENGTH
6 3 -20	6 x 8 mm	110	7 ⅛ 180
02 6 3	9 x 13 mm	mm	in 7 mm
-20 03		110	⅛ in 180
		mm	mm



Foreceps (Nasal Punch)

Gruenwald Nasal Punch Forceps

Jaws with No Cutting Edge

CODE	JAWS	SHAFT	LENGTH
66-3121	2.5 x 9 mm	110 mm	7 ½ in 190 mm



Forceps (Oval Cup)

Oval Cup Forceps

Very Fine 4.0 mm Jaws with Oval Spoon Jaws, 0.9 x 0.2

CODE	DESCRIPTION	LENGTH
61- 0150	75 mm Shaft	5 ¼ 135
61-0150E	Ebonized	in 5 mm
		¼ in 135
		mm



Forceps (Post Nasal)

Hildyard Post Nasal Forceps

CODE	DESCRIPTION	LENGTH
66-2519	Round Cup, 3.5 mm	6 ¾ in 170 mm

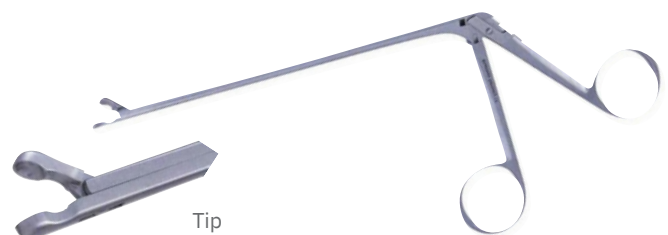

Forceps (Septum)

Asch Septum Straightening Forceps

CODE	DESCRIPTION	JAWS	LENGTH
67-6520	Angled on Flat	7 x 49 mm	8 ¾ in 220 mm



Bruening Septum Forceps

CODE	DESCRIPTION	LENGTH
66-25029	x 11 mm	7 ¾ in 180 mm

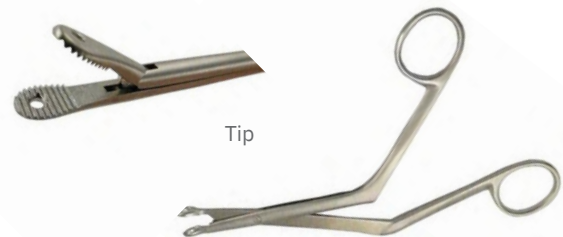

Jansen-Middleton Septum Forceps

Cutting Jaws

CODE	DESCRIPTION	LENGTH
66-25604	x 11 mm	6 ¾ in 170 mm



Jansen-Middleton Septum Forceps

Thru-Cutting Jaws

CODE	DESCRIPTION	SHAFT	LENGTH
66-25654	x 14 mm		7 ½ 190
66-25663	x 13 mm	Narrow	in 7 mm
			½ in 190

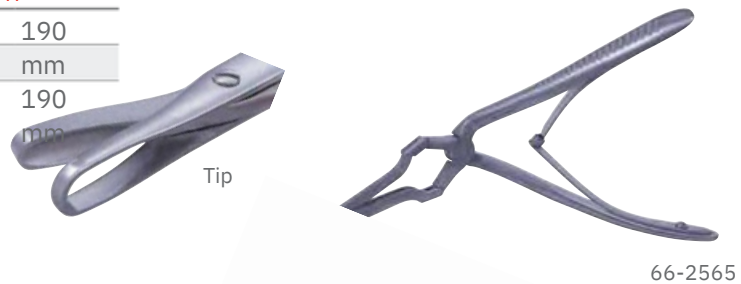

Walsham Septum Straightening Forceps

CODE	DESCRIPTION	LENGTH
67-6513	Bayonet Blades , Straight Jaws	9 in 230 mm



Forceps (Septum)

Septum Morselizing Forceps

DESCRIPTION CODE	LENGTH
Straight 63-5007	7 ¾ 195
Angled 63-5009	in 7 mm ¾ in 195 mm

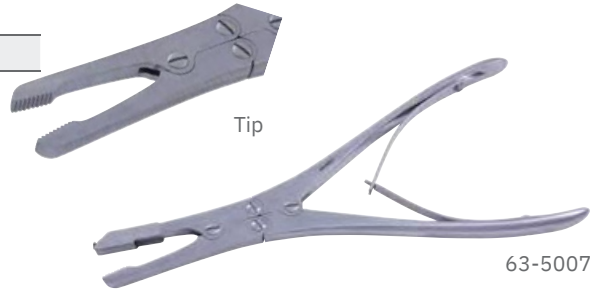

Forceps (Sinus)

Sinus Giraffe Forceps

Double-Action Cupped Forceps

CODE	DESCRIPTION	JAWS	LENGTH
63-5730	70° Horizontal	3 mm	4 ¾ in 120 mm
63-5731	110° Horizontal	3 mm	4 ¾ in 120 mm
63-5732	70° Vertical	4 mm	4 ¾ in 120 mm
63-5733	110° Vertical	4 mm	4 ¾ in 120 mm
63-5734	Horizontal	4 mm	4 ¾ in 120 mm
63-5735	Horizontal	4 mm	4 ¾ in 120 mm

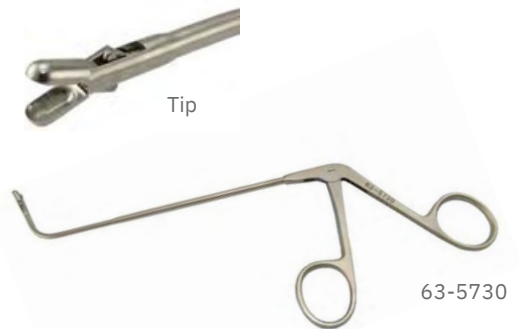

Forceps (Sinus & Nasal)

Circular Cutting Antrum Punch Forceps

Allows Cutting 360° without Rotating the Instrument

CODE	DESCRIPTION	BITE	SHAFT
63-7453	Straight	3.5 mm	170 mm
63-7455	45° Upturned	3.5 mm	170 mm



Forceps (Sinus & Nasal)

Heuwer Antrum Forceps

Fenestrated and Stationary to 90°, Moveable to 120° Jaws, 100 mm Shaft

CODE	JAWS	LENGTH
63-7460	3 x 8 mm	4 in 100 mm



Forceps (Sponge)

Ferris Smith Sponge Forceps

Serrated Jaw

CODE	JAWS	LENGTH
66-2540	6 x 8 mm	7 ½ in 190 mm



Forceps (Tonsil)

Allis-Coakley Tonsil Forceps

One Open Ring Handle

CODE	DESCRIPTION	LENGTH
72-	Straight	7 ½ 190
1002	Slight Curve	in 7 mm
72-	Strong Curve	½ in 190
1003		7 ½ mm
72-		in 190
1004		mm

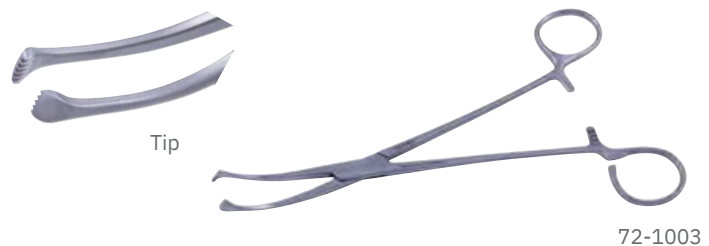

Forceps (Tonsil)

Colver Tonsil Seizing Forceps

CODE	DESCRIPTION	LENGTH
72-4019	Curved	7 ½ in 190 mm



St. Clair Adenoid Forceps

CODE	DESCRIPTION	LENGTH
71-5018	5 x 10 mm, Ring Jaw	7 ¼ in 185 mm



Tivnen Tonsil Forceps

One Open-Ring Handle

CODE	DESCRIPTION	LENGTH
72-1007	3 x 3 Prongs, Angled	8 in 200 mm



White Tonsil Forceps

One Open Ring Handle

CODE	DESCRIPTION	LENGTH
72-1005	Medium Curve	9 ½ in 241 mm

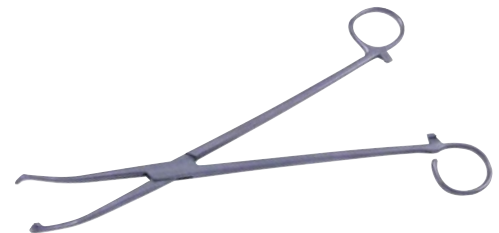

Forceps (Turbinate)

Stryucken Turbinate Forceps

With Sharp Thru-Cutting Edge, 110 mm Shaft

CODE	JAWS	LENGTH
66-3110	1 x 15 mm	6 ¾ in 171 mm



Handles (Knife)

Landolt Knife Handle

CODE	DESCRIPTION	LENGTH
01-2721		8 ¼ in 210 mm
01-2725	Replacement Collet	10 in 250 mm
01-2726		



01-2725

Hooks (Double)

Cottle Double Hook

Sharp Prongs

CODE	DESCRIPTION	LENGTH
67-2003	3 mm Wide	6 in 150 mm



67-2003

Cottle-Joseph Double Hook

Sharp Prongs

CODE	DESCRIPTION	LENGTH
63-0313	2 mm Wide	5 ½ in 140 mm



Freer Double Hook

CODE	DESCRIPTION	PRONGS	LENGTH
20-5202	3 mm Wide	Sharp	6 in 150 mm

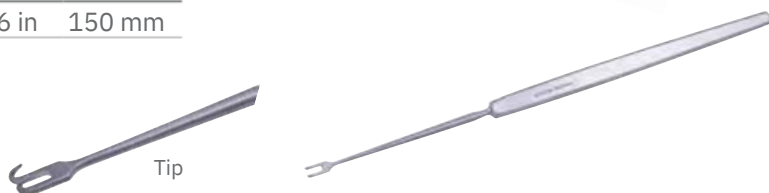

Hooks (Dura)

Adson Dura & Nerve Hook

CODE	DESCRIPTION	PRONGS	LENGTH
20-2722	3 mm Tip	Sharp	8 in 200 mm
20-2723	mm Tip	Blunt	8 in



Hooks (Ear)

Day Ear Hook

CODE	DESCRIPTION	TIP	LENGTH
62-1650	Extra	1.5 mm	6 in 150 mm
62-1651	Small	2 mm	6 in mm
62-1652	Small	2.5 mm	6 in 150 mm
	Large		mm 150 mm

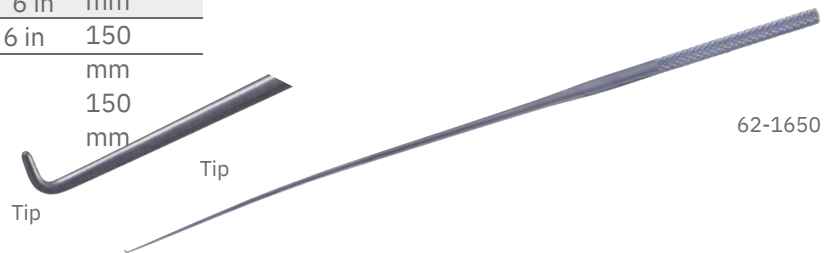

Lillie Ear Hook

Angled 90°

CODE	TIP	LENGTH
61-0024	1 mm Ball	7 in 175 mm



Hooks (Double Fixation)

Double Fixation Hook

CODE	DESCRIPTION	LENGTH
60-1298	1.5 mm Wide	5 ¼ in 135 mm
60-1299	2 mm Wide	¼ in 135 mm

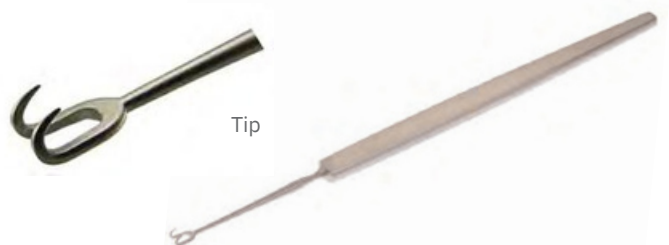

Hooks (Iris, Middle Ear)

Tyrell Iris Hook

CODE	DESCRIPTION
38-6525	Iris Hook



Shea Oblique Hook

CODE	DESCRIPTION	HOOK	LENGTH
62-0425	Angled 90°	Blunt 0.2 mm	6 in 150 mm



Schuknecht Posterior Foot Plate Hook

CODE	DESCRIPTION	TIP	LENGTH
61- 0475	Angled Down Shaft	0.6 mm	6 ½ in 165 mm



Schuknecht Anterior Foot Plate Hook

CODE	DESCRIPTION	TIP	LENGTH
61- 047 3	Angled Up Shaft	0.3 mm	6 ½ in 165 mm



Hooks (Middle Ear)

Shea Foot Plate Hook

Very Fine 4.0 mm Jaws with 0.9 x 0.2 mm Oval Spoon

CODE	DESCRIPTION	TIP SIZE	LENGTH
62-0420	Angled 45°	1	5 ¼ in 135 mm
62-0440	Angled 90°	1 mm	5 ¼ in 135 mm



Saunders-Paparella Stapes Hook

Malleable Shaft, Fine Point

CODE	DESCRIPTION	TIP SIZE	LENGTH
61-3770	Angled Shaft, 90° Angled Tip	0.33 mm	6 ½ in 165 mm



Schuknecht Stapes Hook

Angled Shaft

CODE	DESCRIPTION	TIP	LENGTH
61-0476	Angled 90° Up	1 mm	6 ¼ in 160 mm



Ebonized Schuknecht Hook

CODE	DESCRIPTION	TIP	LENGTH
61-0474E	Shaft Angled Down	0.3 mm	6 ¾ in 170 mm



Hooks (Middle Ear, Nerve, Single)

House Hook

CODE	DESCRIPTION
61-0386	Angled Right 90°



Single Hook

CODE	DESCRIPTION	LENGTH
20 - 5012	2 mm Sharp	5 ¾ in 146 mm



Hooks (Nerves)

Cushing Nerve Hook

CODE	DESCRIPTION	LENGTH
20 -2 2 31	4 mm Ball Tip	7 ½ 190
20-2232	6 mm Ball Tip	in 7 mm
		½ in 190 mm



Hooks (Retractor)

Tracheal Hook

CODE	PRONG	LENGTH
20-6403	3 Sharp Prongs	6 ¼ in 160 mm



Cottle Single Hook

CODE	DESCRIPTION	DETAILS	LENGTH
63-0302	Small	Shallow	5 ¼ 135
63-0303	Small	Curved Deep	in 5 mm
63-0304	Large	Curve Deep	¼ in 135
		Curve	5 ¼ mm
			in 135 mm



Hooks (Skin)

Barsky Skin Hook

CODE	DESCRIPTION	LENGTH
20 -3 501	Single Prong	6 in 150 mm



Converse Skin Hook

CODE	DESCRIPTION	LENGTH
63-0306	Small	7 in 175
6 3 - 0307	Large, Deep Curve	7 in mm 175 mm



Humby Swivel Skin Hook

CODE	DESCRIPTION	TIP	LENGTH
20-3532	Sharp	0.5 mm	4 ½ in 115 mm



Joseph Skin Hook

CODE	DESCRIPTION	HOOK WIDTH	LENGTH
20-5001	Single Prong	4 mm 5 mm	6 ¼ in 160
20-5005	Double	7 mm 10	6 ¼ in mm
20-5007	Prong	mm	6 ¼ in 160
20-5010	Double		6 ¼ in mm
	Prong		160
	Double		mm
	Prong		160
			mm



Kilner Skin Hook

CODE	DESCRIPTION	LENGTH
20 - 5109	Sharp	6 in 150 mm



EAR, NOSE & THROAT

Hooks (Tenaculum)

Cottle Tenaculum Hook

CODE	DESCRIPTION	LENGTH
20 - 4016	Angled	6 ¼ in 160 mm



Hooks (Thimble)

Millard Thimble Hook

CODE	DESCRIPTION	LENGTH
67-2023	Single Prong	3 ¼ in 82 mm



Hooks (Tracheal)

News Tracheal Hook

CODE	DESCRIPTION	LENGTH
20-4015	Single Prong	6 in 150 mm

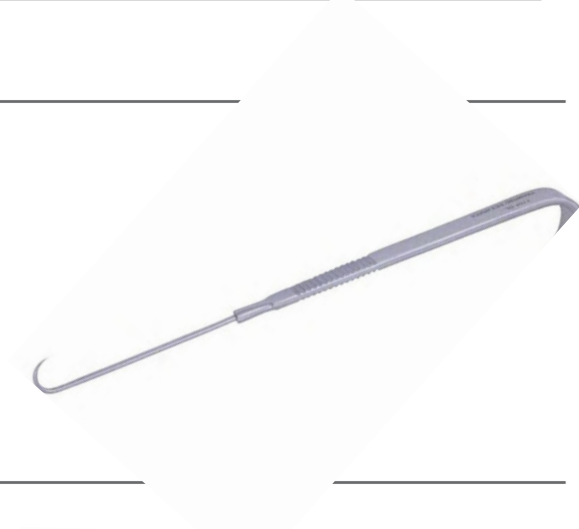

Tracheal Hook

CODE	DESCRIPTION	LENGTH
20-6402	Double-Sharp Prongs	6 ¼ in 160 mm



Hooks (Tracheal)

Tracheal Hook

CODE	DESCRIPTION	LENGTH
20 - 6 502	2 Blunt Prongs	6 ¼ in 160 mm



Inserters (Middle Ear)

Shea Prosthesis Placement Instrument

CODE	DESCRIPTION	TIP SIZE	LENGTH
62-0470	Angled 45°	0.5 mm	6 ¼ in 160 mm



EEAARR,, NNOOSSEE &

Instrument Covers (Forceps Protectors)

Forceps Protectors

CODE	DESCRIPTION
62-4990	10 mm Wide, Protection Tube for Ear Forceps, Autoclavable



Knives (Button End)

Converse Button End Knife

CODE	LENGTH
67-1035	6 in 150 mm



Joseph Button End Knife

CODE	DESCRIPTION	LENGTH
67-	Straight	6 150
1030	Angled	in mm
67-		6 150
1060		in mm



Knives (Canal)

Jordon Canal Knife

Tapered, 2 x 3 mm Blade

CODE	DESCRIPTION	LENGTH
61- 0415	Angled 45°	6 ½ in 165 mm



Knives (Cartilage)

Maltz Cartilage Knife

Blunt Tip, Angled

CODE	DESCRIPTION
67-1065	With Blade Guard

LENGTH
6 ¾ in 170 mm

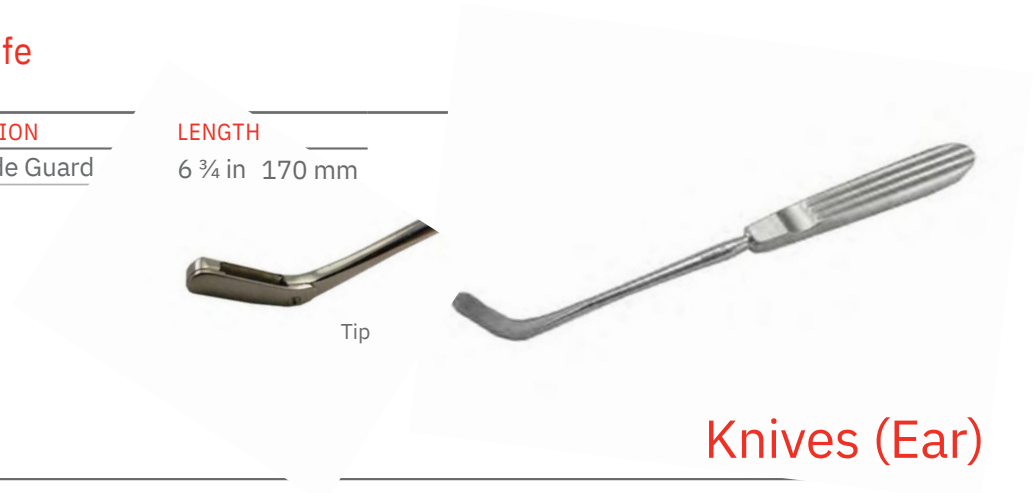

Tip

Knives (Ear)

Ear Knife Blade & Handle

CODE	DESCRIPTION
61-0258	Replacement Baldes (6 per package)
61-0256	Chuck Handle



Tip

Knives (Micro-Laryngeal)

Jako Micro Laryngeal Knife

CODE	DESCRIPTION	LENGTH
74-4510	Sickle Blade	11 5/8 in 295 mm



Knives (Middle Ear)

McCabe Canal Knife

CODE	TIP	BLADE DIAMETER	LENGTH
62-0481	Sharp	2 mm	6 ¾ in 170 mm



Rosen Cartilage Knife

CODE	DESCRIPTION	LENGTH
67-1080	Double-Ended Blades at 45° and 90°	7 ¾ in 195 mm



Guilford-Wright Elevator Knife

TIP WIDTH CODE	LENGTH
2 mm 61-0331	5 ½ in 140 mm



Tabb Flap Knife

Double-Ended

CODE	BLADES	LENGTH
61-0270	Angled 25° and 45°	6 ¼ 160
61-0271	Angled 90° and 120°	in 6 mm
		½ in 165 mm



Knives (Middle Ear)

House Incudostapedial Joint Knife

CODE	ANGLE	BLADE	LENGTH
61-	20°	0.5 x 1.5 mm	6 ½ in 165 mm
0396	60°	0.75 mm	6 ¾ in 170 mm
61-			
0378			

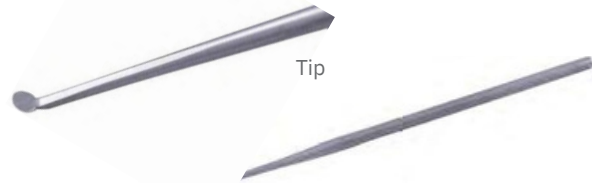

Paparella Incudostapedial Joint Knife

CODE	ANGLE	BLADE	LENGTH
61-0435	20°	0.5 x 1.5 mm	6 ½ in 165 mm



House Lancet Knife

#2 Knife

CODE	ANGLE	BLADE	LENGTH
61-0377	45°	2 x 3 mm	6 ½ in 165 mm

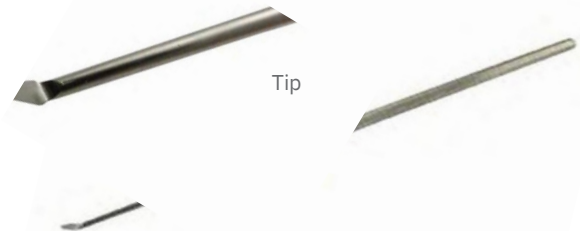

Hough Drum Scraper

Shaft Angled 15°

CODE	POINT/TIP	LENGTH
61-0352	0.5 mm Point Angled 45° on 2.5 mm Tip Angled 60°	6 in 150 mm

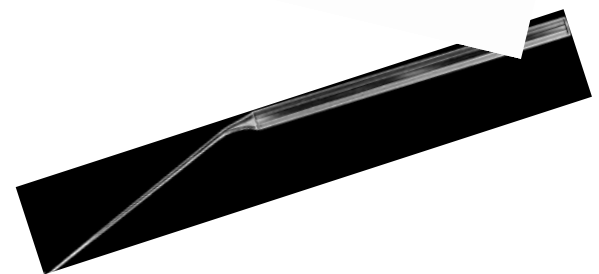

Tabb Myringoplasty Knife

Cur ved

CODE	BLADE	LENGTH
61-0269	Cur ved, 8 mm	6 ½ in 165 mm



Knives (Middle Ear)

House Myringotomy Knife

CODE	BLADE	LENGTH
61- 0397	3.5 mm	6 ½ in 165 mm

Tabb Pick Knife

CODE	BLADE	LENGTH
61-0273	3 mm	6 ¼ in 160 mm

Schuknecht Roller Knife

CODE	BLADE	SHAFT	LENGTH
61- 0470	3 mm	Cur ved	7 ½ in190 mm
61- 047 1	3 mm	90°	7 ½ in190 mm

House Tympanoplasty Knife

CODE	DESCRIPTION	BLADE	LENGTH
61-0395	Cur ved	7 mm	6 ½ in 165 mm



Knives (Middle Ear, Myringotomy, Nasal)

Hough "Whirly Bird" Knife

Strong Curve, 1 x 5 mm Blade

CODE	DESCRIPTION	LENGTH
61-	#1 Angled Right	6 in 150
0344	#2 Angled Left	6 in mm
61-		150
0345		mm

Myringotomy Knife

CODE	DESCRIPTION	LENGTH
61-0266	Straight	5 ¼ in135 mm



Knives (Middle Ear, Myringotomy, Nasal)

Cottle Nasal Knife

CODE	DESCRIPTION	BLADE	LENGTH
67-	Straight	4 mm	5 ¼ in 135
1020	Straight	Round	6 in mm
67-			150
1033			mm



Joseph Nasal Knife

Double Edge Blade

CODE	DESCRIPTION	BLADE	LENGTH
63-	Straight Cur	4 x 18 mm	6 150
0813	ved Cur ved	4 x 22 mm	in mm
63-		4 x 22 mm	6 150
0812 6			in mm
3 -			6 150
0814			in mm



Knives (Middle Ear)

Sickle Knife

Middle Ear

CODE	TIP	ANGLE	LENGTH
61- 0	Sharp 10	30° Left	7 ½ in 190 mm
594 61-	mm Sharp	30° Right	7 ½ in 190 mm
0 59 5	10 mm		



House Sickle Knife

CODE	DESCRIPTION	BLADE	LENGTH
61- 0379	"Number One Knife"	0.75 mm, Cur ved	6 ½ in 165 mm



Paparella Sickle Knife

CODE	DESCRIPTION	BLADE	LENGTH
61-3789	Straight	5.5 mm	6 ½ in 165 mm



Schuknecht Sickle Knife

CODE	DESCRIPTION	SHAFT	LENGTH
61-0469	7 mm	Angled	6 ¼ in 160 mm



Knives (Septum)

Freer Septum Knife

CODE	DESCRIPTION	TIP SIZE	LENGTH
66-5210	"D" Model	5 x 8 mm	6 ¼ in 160 mm
66-5208	Angled	3 mm Angled	7 in 175 mm
66-5201	"E" Model	-	7 ¼ in 185 mm

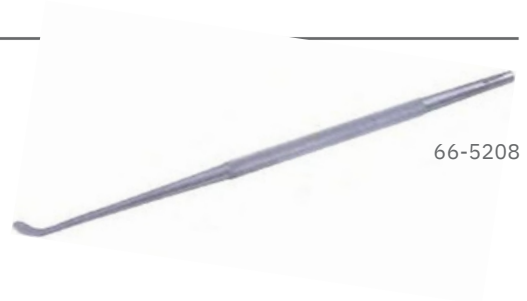

66-5208

Knives (Sinus & Nasal)

Sickle Knife

Curved Blade

CODE	TIP	LENGTH
63-7580	10 mm Sharp	7 ½ in 190 mm
63-7582	10 mm Blunt	7 ½ in 190 mm

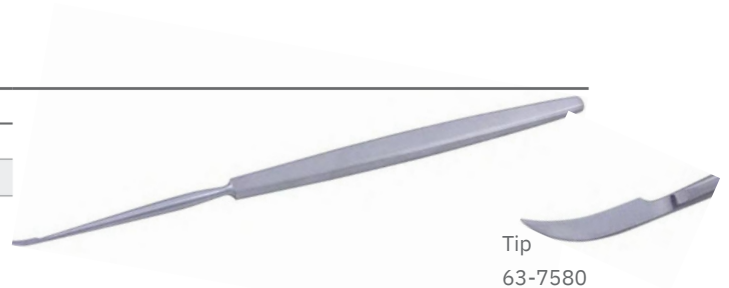
Tip
63-7580

Ballenger Swivel Knife

CODE	DESCRIPTION	BLADE	LENGTH
66-5003	Straight	3 mm	7 ½ in 190 mm
66-5004	Straight	3 mm	in 7 190 mm
66-5005	Straight	3 mm	½ in 190 mm
66-5013	Bayonet	3 mm	7 ½ in 200 mm
66-5014	Bayonet	4 mm	in 8 200 mm
66-5015	Bayonet	5 mm	in 200 mm

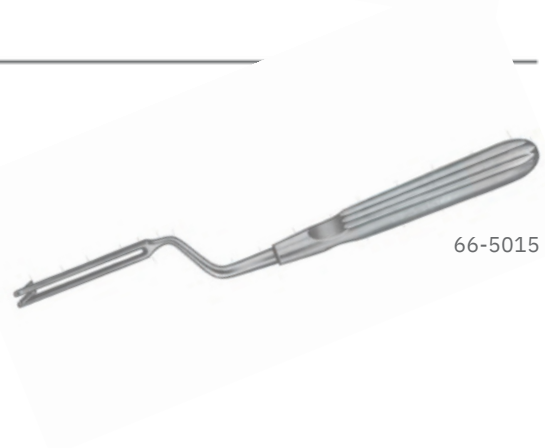

66-5015

Knives (Tonsil)

Canfield Tonsil Knife

CODE	BLADE	LENGTH
72-2030	9 mm Curved	8 ¼ in 210 mm



Knives (Tonsil)

Fisher Tonsil Knife

CODE	DESCRIPTION	LENGTH
72-2540	Slightly Curved Blade	7 ½ in 190 mm



Laryngoscope Holders

Lewy Laryngoscope Holder

CODE	DESCRIPTION
74-3520	Laryngoscope Holder



Loops (Ear)

Billeau Ear Loop

CODE	SIZE	LENGTH
62-	Small	6 ½ 165
1401	Medium	in 6 mm
62-	Large	½ in 165
1402		6 ½ mm
62-		in 165
1403		mm



Mallets (Sinus & Nasal)

Cottle Mallet

One Flat Face and One Round Face

CODE	DESCRIPTION	LENGTH
67-4020	10 oz, 1 ¼ in (31 mm) Diameter Head	7 ½ in 190 mm



Mirrors (Laryngeal)

Laryngeal Mirror

Stationary Octagonal Handle

CODE	DESCRIPTION	SIZE	LENGTH
73-4808	#000	8 mm	6 ¾ in 171
73-4810	#00	10 mm	6 ¾ in mm
73-4812	#0	11 mm	6 ¾ in 171
73-4814	#1	14 mm	6 ¾ in mm
73-4816	#2	16 mm	6 ¾ in 171
73-4818	#3	18 mm	6 ¾ in mm
73-4820	#4	20 mm	6 ¾ in 171
73-4822	#5	22 mm	6 ¾ in mm
73-4824	#6	24 mm	6 ¾ in 171
73-4826	#7	26 mm	6 ¾ in mm
73-4828	#8	28 mm	6 ¾ in 171



Mirrors (Middle Ear)

House Middle Ear Mirror

Straight Shaft

CODE	ANGLE	MIRROR	LENGTH
61-0390	45°	2 mm	6 ½ in 165 mm



Mobilizers (Middle Ear)

Derlacki Mobilizer

CODE	TIP	LENGTH
61-0516	Angled, Serrated Round End	6 ¼ in 158 mm



Hough-Derlacki Mobilizer

CODE	TIP	LENGTH
61-0343	Curved, 4 Pronged, 2 mm Diameter	6 ¼ in 160 mm



Mouth Gags (Tonsil & Laryngeal)

Crowe-Davis Mouth Gag Blades

CODE	DESCRIPTION	SIZE
45	#1 #2 #3	18 x 23 mm
-5111	#4 #5	20 x 62 mm
45		25 x 75 mm
-5112		25 x 95 mm
45		25 x 106 mm
-5113		
45 -		
5114		



45-5111

Crowe-Davis Mouth Gag

CODE	DESCRIPTION	BITE
45-5122	Frame Only, Left	Double Double
45-5121	Frame Only, Right	Silicon Replacement Pads for Mouth Gag Frames 45-5122 and 45-5121
45-5122 x	Set of 2	
45-5126	Child Right	



45-5122

McIvor Mouth Gag & McIvor Tongue Blade

CODE	DESCRIPTION	SIZE
45-5300	Complete Set, Includes 1 of each of the items listed below.	
45-	Mouth Gag	Frame Only
5320 45	Tongue Blade #1	22 X 69 mm
- 5 311	Tongue Blade #2	24 X 90 mm
45 - 5	Tongue Blade #3	25 X 100 mm
312 45 -		
5 313		



45-5320



45-5313

Ring Blade

CODE	DESCRIPTION	SIZE
45	Left Left Left #	2 1/8 x 8 in 60 x 22
-2140	Left Right 2	3 x 1 1/2 in mm 76 x
45 -2	Right #	3 3/4 x 12 in 28 mm 95
141 45	Right 3	3 1/4 x 14 in x 36 mm
-2 14 3	Right #	2 1/8 x 8 in 90 x 32
45 -2		5 3 x 1 1/2 in mm 60 x
142 45	#	3 1/4 x 14 in 22 mm 76
-2 14 4		4 3 3/4 x 12 in x 28 mm
45 -2	#	95 x 36
145	2	mm
45	#	mm



45-2140

Mouth Gags (Tonsil & Laryngeal)

Russel-Davis Tongue Blade

CODE	BLADE SIZE
45-5331	33 x 75 mm
45-5332	38 x 85 mm
45-5333	40 x 92 mm



45-5331

Dingman Mouth Gag

CODE	DESCRIPTION
72-0800	Complete Set includes Frame, 2 Lateral Cheek Retractors and the 3 Grooved Blades listed below.
72-0801	Frame Only
72-0811	Small, Blades with Groove 25 x 55 mm
72-0812	Medium, Blades with Groove 27 x 60 mm
72-0813	Large, Blades with Groove 30 x 70 mm



72-0800

Jennings Mouth Gag

Standard Pattern

CODE	DESCRIPTION	LENGTH
72-0709	Extra Small	3 3/8 in 90 mm
72-0711	Small	4 3/8 in 112 mm
72-0713	Medium	5 1/8 in 130 mm
72-0715	Large	6 in 150 mm

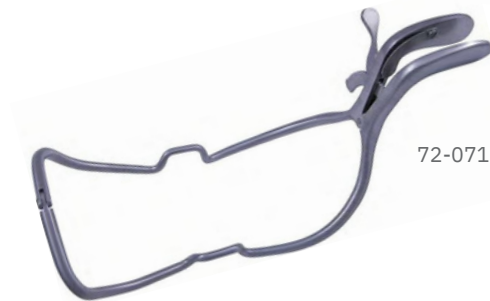

72-0715

Mouth Gags (Tonsil & Laryngeal)

Sluder Jansen/Schink Mouth Gag

CODE	DESCRIPTION	LENGTH
72-0515	Adult	4 1/4 in 108 mm



Mouth Gags (Tonsil & Laryngeal)

Denhardt Mouth Gag

Self-Retaining

CODE	DESCRIPTION
72-0560	Serrated, No inserts needed (Silicon pads not used with this item)
72-0561	Frame for use with Silicon Pads 72-0560x
72-0560x	Silicon Inserts for use with 72-0561



72-0560

McKesson Mouth Prop

Sold in pairs, Black

CODE	DESCRIPTION
62-	Infant
1211 6	Child
8 -12	Adult
12 6 8	
-12 14	



6 8 -12 14

Needles (Middle Ear)

Shambaugh-Derlacki Needle

CODE	DESCRIPTION	LENGTH
61-0408	Straight Tip with Angled Shaft, Fine	6 ¼ in 160 mm
61-0409	Straight Tip with Angled Shaft, Super Fine	6 ¼ in 160 mm



61-0408

McGee Perforating Needle

CODE	DESCRIPTION	LENGTH
61-0431	Straight Point on Angled Shaft	6 ½ in 165 mm



Needles (Middle Ear)

House-Rosen Type Needle

Cur ved

CODE	DESCRIPTION	TIP	LENGTH
61-0361	Justify left	SIZE	6 ½ in 165
61-0366	Slightly Dulled Point	3 mm	½ in mm
		4 mm	165 mm



Schuknecht Stapes Needle

CODE	DESCRIPTION	LENGTH
61- 047 7	Angled Shaft, Straight Tip	6 ¼ in 160 mm



Austin Needle

CODE	DESCRIPTION	TIP SIZE	LENGTH
61-0305	Slightly Curved	10 mm	6 ¼ in 160 mm



House Needle

CODE	DESCRIPTION	TIP SIZE	LENGTH
61- 03 59	Curved, Sharp Point	4 mm	6 ½ in 165 mm

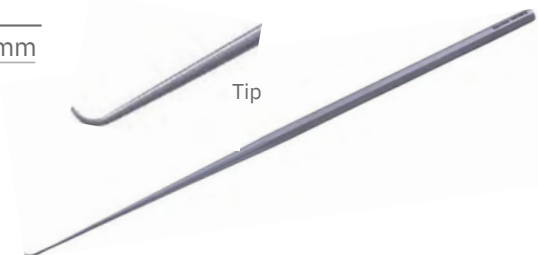

Saunders-Paparella Needle

Straight, Malleable Shaft, Fine Point

CODE	DESCRIPTION	LENGTH
61-3750	#5, Fine	6 ½ 165
61-3752	#6, Heavy	in 6 mm
		½ in 165
		mm



Needles (Septum)

Septum Needle

CODE	DESCRIPTION
63-7591	90° Tip, Straight Shaft, 22 Gauge



Needles (Tonsil)

Tonsil Needle

23 Gauge

CODE	DESCRIPTION	NEEDLE EXTENSION
72-	45° Angle	13 mm
9514	Straight	13 mm
72-9510		



Nippers (Middle Ear)

House-Dieters Malleus Nipper

75 mm Shaft

CODE	DESCRIPTION	LENGTH
61-	1.5 mm Jaws	5 125
015 8	2 mm Jaws	in mm
61-		5 125
0157		in mm



Nippers (Malleus)

Malleus Nipper

Delicate, Non-Serrated

CODE	DESCRIPTION	LENGTH
61-0700	7 mm Jaws	4 ½ in 115 mm



Sponges

Secto® Tonsil Sponges

Sterile Pack, 5 Per Card/Pouch, 25 Pouches Per Dispenser, 2 Dispensers Per Case

CODE	DESCRIPTION	SIZE
81-1010	X-Ray Detectable	36mm
81-1011	X-Ray Detectable	25mm
81-1012	X-Ray Detectable	4 ½ in 32 mm

Note: Cord Length on all sizes is 10 in (254 mm)

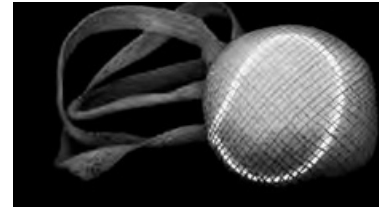

81-1010

Osteotomes

Anderson-Neivert Osteotome

CODE	DESCRIPTION	WIDTH	LENGTH
63 - 0120	Curved Left	4	8 ¼ in 210 mm
63 - 0119	Curved Right	mm	8 ¼ in 210 mm
		4	
		mm	



63-0120

Converse Osteotome

CODE	DESCRIPTION	LENGTH
67-3102	2 mm	7 175
67-3104	4 mm	in mm
67-3106	6 mm	7 175
67-3108	8 mm	in mm
67-3110	10 mm	7 175
67-3112	12 mm	in mm
		7 175
		in mm
		7 175
		in mm
		7 175
		in mm



67-3102

Cottle Osteotome

Very Delicate, Round Corners

CODE	DESCRIPTION	LENGTH
63 - 0103	4 mm Wide	7 in 175
0103 6	6 mm Wide	7 in mm
3 - 0104	9 mm Wide	7 in 175
63-	12 mm	7 in mm
0105	Wide	175
63-		mm
0106		175



63-0103

Osteotomes

Neivert Osteotome

CODE	DESCRIPTION	GENERATOR PLUG	LENGTH
63-0121	Straight	With 4 mm Single Guarded Edge	8 in 200 mm



Osteotome

CODE	TIP WIDTH	LENGTH
63-0092	2 mm 3	6 ¼ in 160
63-0093	mm 4	6 ¼ in mm
63-0094	mm 5	6 ¼ in 160
63-0095	mm 6	6 ¼ in mm
63-0096	mm 7	6 ¼ in 160
63-0097	mm 8	6 ¼ in mm
63-0098	mm 9	6 ¼ in 160
63-0099	mm 10	6 ¼ in mm
63-0100	mm 11	6 ¼ in 160
63-0101	mm 12	6 ¼ in mm
63-0102	mm	mm



Ristow Osteotome

CODE	DESCRIPTION	LENGTH
63-0122	Curved Right	8 in 200 mm



Rubin Osteotome

Rounded Corners with Finger Guard

CODE	DESCRIPTION	LENGTH
63-0107	10 mm Width, With 8 mm Cutting Edge	6 ½ in 165 mm
63-0108	14 mm Width, With 12 mm Cutting Edge	6 ½ in 165 mm
63-0109	16 mm Width, With 14 mm Cutting Edge	6 ½ in 165 mm



EAR, NOSE & THROAT

Osteotomes

Silver Osteotome

5.0 mm Wide Angled Blade with Single Guarded Edge

CODE	DESCRIPTION	LENGTH
67-3810	Straight	7 ¼ 185
67-3811	Right	in 7 mm
67-3812	Left	¼ in 185
		7 ¼ mm
		in 185
		mm



67-3812

Tessier Osteotome

CODE	DESCRIPTION	WIDTH	LENGTH
6 3 - 0151	Straight	3.5 mm	6 ¼ in 160 mm



Osteotomes (Guarded)

Cinelli Double Guarded Osteotome

CODE	TIP WIDTH	LENGTH
6 3 -37	10	6 150
10 6 3	mm	in mm
-37 12	12	6 150
6 3 -37	mm	in mm
14 6 3	14	6 150
-37 16	mm	in mm
	16	6 150
	mm	in mm



63-3710

Converse Single Guarded Osteotome

CODE	DESCRIPTION	WIDTH	EDGE	LENGTH
6 3 -	Straight	6 mm		7 ½ 190
0117 6	Curved Left	6 mm		in 7 mm
3 -	Curved Right	6 mm	4.5 mm	½ in 190
0116 6				7 ½ mm
3 -				in 190
0115				mm



63-0116

Cottle Guarded Osteotome

CODE	DESCRIPTION	WIDTH	LENGTH
6 3 - 0118	Straight	6 mm	7 ½ in 190 mm



Osteotomes (Guarded)

Fomon Guarded Osteotome

CODE	TIP WIDTH	LENGTH
63 - 0112	7 mm	6 ½ in 165 mm



Picks (Middle Ear)

House-Barbara Pick

CODE	DESCRIPTION	LENGTH
61-0365	Straight Tip, Malleable Shaft	6 ½ in 165 mm



Shea Pick

CODE	DESCRIPTION	LENGTH
61-0483	Blunt	6 ½ in 160 mm



House-Crabtree Dissector Pick "Jimmy"

Flat Tip, Angled 90°

CODE	DESCRIPTION	LENGTH
61-0392	Small Large 0.8 x 1.5	6 ½ 165
61-0391	mm 0.5 x 2.5 mm	in 6 mm ½ in 165 mm



Picks (Middle Ear)

Hough Foot Plate Pick

Slightly Curved Tip

CODE	DESCRIPTION	LENGTH	
61-	Fine Pattern	6	150
0336	Heavy Pattern	in	mm
61-		6	150
0335		in	mm



Hough "Hoe" Pick

0.5 mm Tip, Angled Shaft

CODE	DESCRIPTION	LENGTH	
61-0351	Tip Angled 45°	6	150
61-0340	Tip Angled 90°	in	mm
		6	150
		in	mm



61-0351

House Obtuse Pick

CODE	DESCRIPTION	LENGTH	
61- 037 1	0.33 mm Tip, Angled 30°	6 ½ in	165 mm



House Oval Window Pick

CODE	DESCRIPTION	LENGTH	
61- 037 3	0.33 mm Tip, Medium Shaft, Tip Angled 90°	6 ½ in	165 mm
61-0383	0.33 mm Tip, Angled 30° on Straight Malleable Shaft	6 ½ in	165 mm
61-0384	0.66 mm Long Tip, Angled 30° on Straight Malleable Shaft	6 ½ in	165 mm



61-0373

Picks (Middle Ear)

Hough Stapedectomy Pick

CODE	DESCRIPTION	LENGTH
61-0338	0.33 mm tip, Angled 90° Shaft	6 in 150 mm

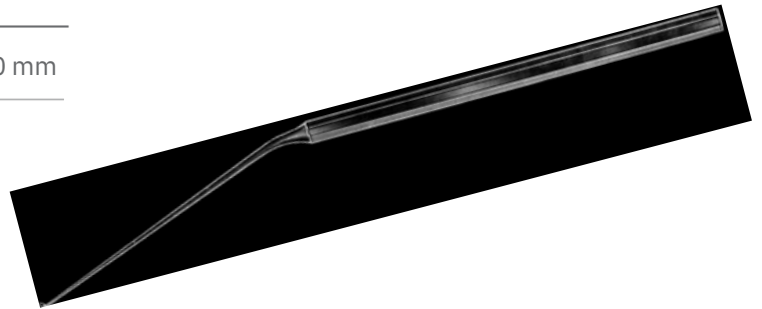

House Strut Pick

Malleable Medium Shaft

CODE	DESCRIPTION	TIP	LENGTH
61-0374	Angled 90°	0.5 mm	6 ½ in 165 mm
61-0375	Angled 90°	0.66 mm	6 ½ in 165 mm



House Window Pick

Fine shaft

CODE	DESCRIPTION	LENGTH
61-0372	0.33 mm, Angled 90°	6 ½ in 165 mm



Austin Pick

CODE	ANGLE	GENERATOR PLUG	LENGTH
61-0317	25°	1 mm Tip	6 ¼ in 160 mm
61-0306	45°	1 mm Wide Tip	6 in 160 mm
61-0308	90°	1 mm Wide Tip	¼ in 160 mm
61-0307	90°	3 mm Wide Tip	6 ¼ in 160 mm

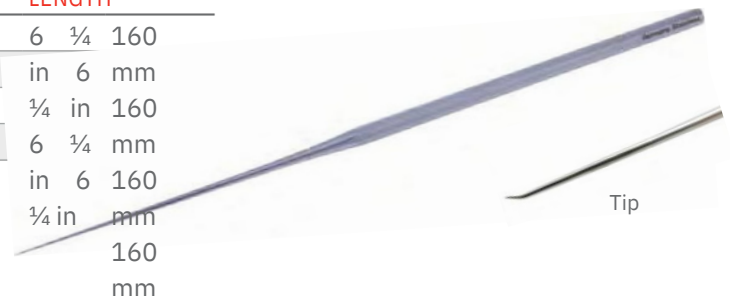

Picks (Middle Ear)

McGee Pick

CODE	DESCRIPTION	POINT	LENGTH
61-0425	Anterior Angled 90° Up	0.2 mm	6 ½ in 165 mm
61-0426	Posterior Angled 90° Down	0.2 mm	6 ½ in 165 mm



61-0425

Paparella Pick

CODE	DESCRIPTION	BLADE	LENGTH
61-3812	Angled Left	1 x 4	6 ½ in 165 mm
61-3 810	Angled Right	mm 1 x 4 mm	6 ½ in 165 mm



61-3812

Rosen Pick

CODE	DESCRIPTION	LENGTH
61-0445	Curved Tip	6 ½ in 165 mm
61-0446	Angled Tip	6 ½ in 165 mm



61-0445

Tip

Hough Pick

Straight Malleable Heavy Shaft

CODE	DESCRIPTION	LENGTH
61-0349	Straight Tip	6 in 150
61-0387	1 mm Tip	6 ½ mm
61-0388	1.5 mm Tip	in 165
61-0389	3 mm Tip	6 ½ mm
61-0389		in 165
61-0389		6 ½ mm
61-0389		in 165
61-0389		mm



61-0349

Picks (Middle Ear)

Kos Pick

CODE	DESCRIPTION	LENGTH
61-7723	Bayonet Shaft, 0.33 mm Point 90°	7 in 180 mm



Tip

Presses

Sheehy Fascia Press

CODE	GENERATOR PLUG	LENGTH
61-0 517	23 x 31 mm Plate	7 ½ in 190 mm



House Gelfoam Press

CODE	DESCRIPTION	LENGTH
61-0 518	16 x 12 mm Plate	7 ½ in 190 mm
61-0 519	16 x 12 mm plate	5 in 130 mm



61-0519

Probes (Laryngeal)



Jako Laryngeal Probe

DESCRIPTION CODE	WORKING LENGTH	LENGTH
Straight 74-4520	8 5/8 in 220 mm	11 5/8 in 295 mm
Angled 74-4521	8 5/8 in 220 mm	11 5/8 in 295 mm

Probes (Periodontal)



Periodontal Probe

CODE	DESCRIPTION	LENGTH
69 - 62 18	Dental Probe	6 in 152 mm

Probes (Sinus)



Ostium Seeker Probe

With Double-Ended Ball Tips

CODE	DESCRIPTION	ANGLE	BALL TIPS	LENGTH
63-8820	Frontal Sinus	One End 90°		8 1/4 210
63-8825	Maxillary Sinus		2.3 and 2.6 mm	in 8 mm
				1/4 in 210 mm

Probes (Sinus)

Skillern Sinus Probe

CODE	DESCRIPTION	LENGTH
09-1300	Malleable with Centimeter Graduations at 50 mm, 70 mm and 90 mm	6 ½ in 165 mm

Punches (Sinus)



Access Down Biting Punch

CODE	DESCRIPTION	DIAMETER	WORKING LENGTH
11-311	90° Down Biter, Left	3.8 mm	4 5/8 in 115 mm
11-321	90° Down Biter, Right	3.8 mm	5/8 in 115 mm

Punches (Adenoid)



King Adenoid Punch

CODE	DESCRIPTION	BITE	BASKET	LENGTH
72-6179	Triangular Basket	6 mm	7 mm	7 in 175 mm

Punches (Adenoid)



Tip



71-4001

Meltzer Adenoid Punch

CODE	DESCRIPTION	BASKET	SHAFT	BITE	LENGTH
71-4001	#1	6 mm,	120	5	8 ¼ 210
71-4002	#2	Round 7 mm, Round	120 mm	7 mm	¼ in 210 mm



Tip



71-5001

Ronis Adenoid Punch

DESCRIPTION CODE	SIZE	LENGTH
#1, Triangular Basket, Curved Up, Shaft 120 mm 71-5001	7 mm	8 ¼ in 210 mm
#2, Triangular Basket, Curved Up, Shaft 120 mm 71-5002	Basket 8 mm Basket	8 ¼ in 210 mm



Tip



71-5222

Meltzer Adenoid Punch

CODE	DESCRIPTION	BASKET	SHAFT	BITE	LENGTH
71-5220	#0	5 mm,	120	4	7 ¾ 197
71-5222	#1	Triangular 7 mm, Triangular	120 mm	6 mm	¼ in 197 mm

Punches (Sinus & Nasal)



Backbiting Antrum Punch

Adult, 2.5 x 7 mm Bite, Shaft 90 mm

CODE	DESCRIPTION	LENGTH
63-7625	Straight	7 3/8 in 187 mm
63-7627	Left Side Cutting	7 3/8 in 187 mm
63-7626	Right Side Cutting	7 3/8 in 187 mm



Antrum Cutting Punch

CODE	DESCRIPTION	BITE	LENGTH
63-7610	45° Backward Cutting	4 x 5 mm	8 1/4 in 210 mm
63-7615	45° Forward Cutting	4 x 5 mm	8 1/4 in 210 mm
63-7631	90° Down Cutting	5 mm 4	8 3/4 in 210 mm
63-7630	90° Up Cutting	4 x 8 mm	8 3/4 in 210 mm

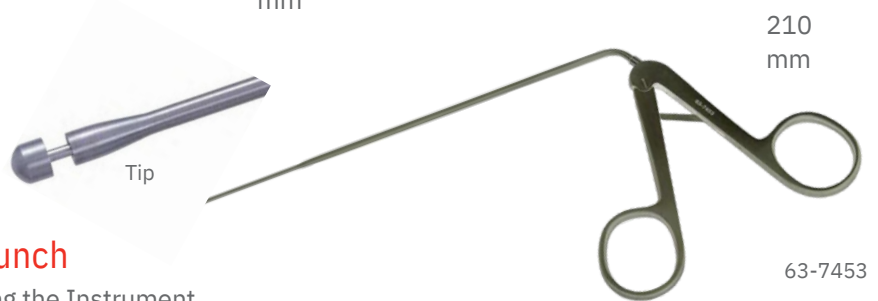

Circular Cutting Antrum Punch

Allows Cutting 360° without Rotating the Instrument

CODE	DESCRIPTION	BITE	SHAFT
63-7453	Straight Straight	3.5 mm	7 in 180 mm
63-7454	65° Degree Upturn	4.5 mm	7 in 180 mm
63-7455		3.5 mm	6 3/4 in 170 mm

EAR, NOSE & THROAT

Punches (Sinus & Nasal)



Pediatric Backbiting Antrum Punch

CODE	DESCRIPTION	BITE	SHAFT	LENGTH
63-7420	Straight	1.5 x 5	4 1/8 105	8 1/4 in 210
63-7422	Left Side Cutting	mm 1.5 x	in 4 mm	8 1/4 in mm
63-7421	Right Side Cutting	5 mm 1.5	1/8 in 105	8 1/4 in 210
		x 5 mm	4 1/8 mm	mm
			in 105	210
			mm	mm

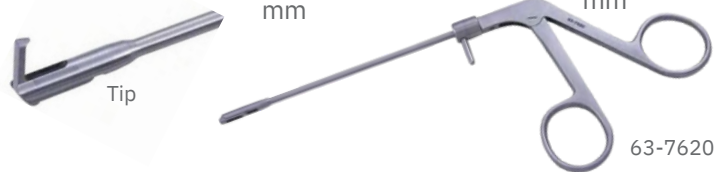

Rotating Backbiting Antrum Punch

With Post for One Hand Rotation of 360°

CODE	DESCRIPTION	BITE	SHAFT	LENGTH
63-741	Pediatric	1.5 x 5	100	8 in 203 mm
5 63-7416	Pediatric	mm 1.5 x	mm	8 1/2 in 215 mm
63-7416	Adult	5 mm 2.5	100	8 in 200 mm
63-7620		x 7 mm	mm	
			100	
			mm	



Side Biting Antrum Punch

Thru-Punch, Designed to Cut Down, Right, Left and Forward

CODE	DESCRIPTION	SHAFT	LENGTH
63-7452	Left Side Cuts Down and Sideways	3 7/8 100	8 1/2 in 215 mm
63-7451	Right Side Cuts Down and Sideways	in 3 mm	8 1/2 in 215 mm
		7/8 in 100	
		mm	



Access Small Punch

CODE	DESCRIPTION	DIAMETER	WORKING LENGTH
11-301	Straight	3.3	3 7/8 in 97
11-341	Up 45°	mm	3 3/8 in mm
		3.3	94
		mm	mm

Punches (Sinus & Nasal)



Tip



11-302

Access Medium Punch

CODE	DESCRIPTION	DIAMETER	WORKING LENGTH
11-	Straight	4 mm	3 7/8 in 97
302	Up 45°	4 mm	3 3/8 in 94
11-342			94 mm



Tip



11-303

Access Large Punch

CODE	DESCRIPTION	DIAMETER	WORKING LENGTH
11-	Straight	6.1 mm	4 in 100 mm
303	Up 45°	6.1 mm	3 7/8 in 97 mm
11-343			



Hajek-Kofler Punch

CODE	DESCRIPTION	JAWS	SHAFT	LENGTH
66-3810	360° Rotatable	3 x 7 mm Solid Biting	5 7/8 in 150 mm	9 1/2 in 240 mm



Tip



11-303

Access Suction Punch

CODE	DESCRIPTION	DIAMETER	WORKING LENGTH
11- 4	Straight	4 mm	3 5/8 in 93 mm
02	Up 45°	4 mm	3 1/2 in 93 mm
11- 4			3 1/8 in
42			

Punches (Sinus & Nasal)

Access Toffel Punch

Thru- Cut ting



Tip



11-371

CODE	DESCRIPTION	DIAMETER	WORKING LENGTH
11-371	Left	3	3 7/8 97
11-372	Right	mm	in 3 mm
		3	7/8 in 97
		mm	mm

Punches (Sphenoid)



Tip



McKenty Sphenoid Punch

CODE	DESCRIPTION	JAWS	SHAFT	LENGTH
66-3812	360° Rotatable	1.5 x 4 mm Thru-Biting	5 5/8 in 145 mm	7 in 175 mm



Tip



11-502

Sphenoid Punch

CODE	DESCRIPTION	WORKING LENGTH
11-502	3.5	4 1/2 115
	mm	in 4 mm
11-504	4.5	1/2 in 115
	mm	mm

Rasps (Bone & Skin)

Bone & Skin Rasp

CODE	DESCRIPTION	LENGTH
26-0513	Bone and Skin Rasp	5 3/8 in 130 mm

Rasps (Middle Ear)



McGee Oval Window Rasp

CODE	DESCRIPTION	ANGLE	DIAMETER	LENGTH
61-0429	Small Large	20°	0.4 mm	6 ½ in 165 mm
61-0430		20°	0.7 mm	in 6 mm ½ in 165 mm

Rasps (Nasal)



Aufrecht Nasal Rasp

CODE	WIDTH	CUTTING DIRECTION	LENGTH
67-5941	8 mm	Down - Cut ting	8 ¼ in 210 mm
67-5942	8 mm	Up - Cut ting	in 8 mm ¼ in 210 mm



Fomon Nasal Rasp

CODE	DESCRIPTION	LENGTH
67-5960	Double-Ended, with 4 Working Surfaces, 2 Surfaces with Fine and 2 with Coarse Serrations, Flat and Convex	8 ¾ in 220 mm



Peet Nasal Rasp

CODE	DESCRIPTION	LENGTH
63-0560	Straight, Fine Tungsten Carbide Dust Surface	7 ½ in 190 mm

Rasps (Sinus & Nasal)



Good Antrum Rasp

CODE	LENGTH
67-5920	6 ¾ in 170 mm

66-6233

Wiener Antrum Rasp

CODE	TIP	LENGTH
66-6232	Extra-Small Trocar	7 ½ 190
66-6234	Small Trocar	in 7 mm
66-6233	Large Trocar	½ in 190
		7 ½ mm
		in 190
		mm

Dingman Otoabrader Rasp

10 Fine Teeth

CODE	DESCRIPTION	LENGTH
67-5912	Curved Left	6 ¼ 160
67-5911	Curved Right	in 6 mm
		¼ in 160
		mm



60-6054

Obwegeser Push Pull Rasp

One Working End Operates by Pushing, the Other End by Pulling

CODE	DESCRIPTION	LENGTH
67-	Straight, Delicate	7 ½ 190
6051	Straight, Medium/Fine	in 7 mm
67-	Curved, Delicate	½ in 190
6052	Curved, Medium/Fine	7 ½ mm
67-	Concave, Delicate	in 7 190
6053	Concave, Medium/Fine	½ in mm
67-		7 ½ 190
6054		in mm
67-		190

Rasps (Sinus & Nasal)

Tungsten Carbide Rasp

Straight, Double-Ended, Down-Cutting



CODE	DESCRIPTION	LENGTH
63-0516	Very Fine Grit #1 and Fine Grit #2	8 ¼ 210
63-0518	Fine Grit #3 and Coarse Grit #4	in 8 mm
63-0520	Coarse Grit #5 and Coarse Grit #6	¼ in 210
63-0522	Coarse Grit #7 and Very Coarse Grit #8	8 ¼ mm
		in 8 210
		¼ in mm
		210
		mm



Aufricht-Glabella Rasp

CODE	DESCRIPTION	LENGTH
67-5940	Curved Backwards, Cross Serrated, Up - and Down-Cutting	7 ½ in 190 mm



Cottle Rasp

CODE	DESCRIPTION	LENGTH
67-5935	24 Straight, Fine, Down-Cutting Teeth	8 ¼ in 210 mm



Fomon Rasp

Double-Ended Convex and Flat Ends, Down-Cutting

CODE	DESCRIPTION	LENGTH
63-0511	Fine Teeth	8 ⅜ 212
63-0512	Coarse Teeth	in 8 mm
		⅜ in 212
		mm

Rasps (Sinus & Nasal)



63-0503

Joseph Rasp

CODE	DESCRIPTION	WIDTH	LENGTH
63-0503	Fine, Single-Ended	2 mm	7 ¼ 185
63-0504	Course, Single-Ended	Wide 2 mm Wide	in 7 mm ¼ in 185 mm



Tip

Kleinert-Kutz Rasp

Double-Ended with One Flat End and One Convex End

CODE	DESCRIPTION	LENGTH
67-5970	Coarse Teeth on One Side and Fine Teeth on the Other Side	8 ½ in 215 mm



Tip

Lewis Rasp

CODE	DESCRIPTION	LENGTH
67-5930	Down-Cutting Teeth	7 in 175 mm



Tip

63-0507

Maltz Rasp

CODE	DESCRIPTION	LENGTH
63-0507	Down-Cutting Pattern	6 ½ 165
63-0508	Up-Cutting Pattern	in 6 mm ½ in 165 mm

Rasps (Sinus & Nasal)

Maltz Rasp

Fine Tungsten Carbide Inserts



63-0551

CODE	DESCRIPTION	LENGTH	
63-0551	Down-Cutting Pattern	7	170
63-0550	Up-Cutting Pattern	in	mm
		7	170
		in	mm

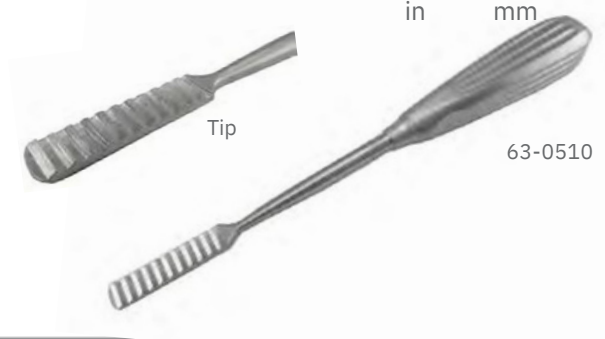

63-0510

Parkes Rasp

Down - Cut ting

CODE	DESCRIPTION	LENGTH	
63-0509	20 Fine, Concave Teeth	7 ¾	195 mm
63-0510	11 Coarse, Concave Teeth	in 7	195 mm
		¾ in	



63-0498

Rasp

Fine Tungsten Carbide Dust Teeth

CODE	DESCRIPTION	SURFACE	LENGTH
63-0500	Straight Straight	Convex	7 ½ 190
63-0501	Straight Cur ved	Concave	in 7 mm
63-0505	Curved Backwards	Concave	½ in 190
63-0506	Curved Backwards	Convex	7 ½ mm
6 3 -	Curved Backwards	Convex	in 7 190
0494	Curved Forward	Concave	½ in mm
63-0495	Curved Forward	Flat	7 ½ 190
6 3 -	Curved Forward	Convex	in 7 mm
0496 6 3		Concave	½ in 190
- 0498 6		Flat	7 ½ mm
3 - 0498			in 7 190
6 3 -			½ in mm

EAR, NOSE & THROAT

Retractors (Cheek)

Cheek Retractor

CODE	DESCRIPTION
72-0240	With Swivel

LENGTH

8 ¼ in 209 mm



Retractors (Hand-Held)

Aufricht Retractor

CODE	WIDTH	LENGTH
67-2135	45 mm	7 ⅛ 180 mm
67-2136	60 mm	in 7 180 mm
67-2137FO	70 mm, Fiber Optic Light Guide	⅞ in 175 mm
		7 in



67-2135



Tip

Blair (Rollet) Retractor

CODE	WIDTH	PRONGS	LENGTH
6 3 - 4010	6 mm	4 Sharp	5 in 125 mm



Tip

67-2021

Cottle Retractor

Double-Prong, One Sharp and One Ball Tip

CODE	DESCRIPTION	LENGTH
67-2021	Right Prong, Sharp	5 ½ 140
67-2022	Left Prong, Sharp	in 5 mm
		½ in 140
		mm

Retractors (Hand-Held)



Cottle-Neivert Retractor

Knife Guide and Retractor

CODE	DESCRIPTION	PRONGS	WIDTH	LENGTH
67-2051	Double -	Ball		7 ¾ 195
67-2052	Ended Double - Ended	Blunt	10 mm	in 8 mm ¼ in 210 mm



Crile Retractor

CODE	DESCRIPTION	LENGTH
20-0930	Double-Ended	4 ¾ in 110 mm



Heiss Retractor

CODE	PRONGS	LENGTH
24-0909	4 x 4 Prongs, Sharp	4 100
24-0910	4 x 4 Prongs, Blunt	in mm 4 100 in mm

Retractors (Tracheal)



Jackson Tracheal Tenaculum

CODE	DESCRIPTION	LENGTH
20 - 4014	Single Prong	5 ¾ in 145 mm

Retractors (Hand-Held)

Knapp Retractor

WIDTH CODE	PRONGS	LENGTH
6 mm 6 mm	4 Sharp	5 125
20 516	4 Blunt	in mm
- 5 517		5 125
		in mm



Murphy Retractor

CODE	PRONGS	LENGTH
22-5002	2 Sharp	7 ¾ in 195 mm
22-5004	4 Sharp	7 ¾ in 195 mm
22-5006	6 Sharp	7 ¾ in 195 mm
22-5102	2 Blunt	7 ¾ in 195 mm
22-5103	3 Blunt	7 ¾ in 195 mm
22-5104	4 Blunt	7 ¾ in 195 mm
22-5106	6 Blunt	7 ¾ in 195 mm



Perkins Retractor

Three Sharp Prongs and Solid Blades with Spikes

CODE	DESCRIPTION	SPREAD	LENGTH
66-6650	3 Prongs on Left with Solid Blade	5 in 125 mm	5 125
66-6651	Right 3 Prongs on Right with Solid Blade Left	5 in 125 mm	in mm
			5 125
			in mm



Ragnell Retractor

Double-Ended

CODE	BLADES	LENGTH
20-0525	2.5 mm 5 mm	6 ¼ in 160 mm



Retractors (Tracheal)

Ragnell Retractor

Double-Ended



CODE	BLADES	LENGTH
20-0526	3 mm 5 mm	6 ¼ in 160 mm



Senn Retractor

Double-Ended

CODE	PRONGS	LENGTH
20-0508	Sharp	6 ¼ 160
20-0509	Blunt	in 6 mm
		¼ in 160
		mm



Volkman Retractor

CODE	PRONGS	LENGTH	22-3402
22-	2	8 ¾ in	220 mm
3402	Sharp	8 ¾ in	220 mm
22-	3	8 ¾ in	220 mm
3403	Sharp	8 ¾ in	220 mm
22-	4	8 ¾ in	220 mm
3404	Sharp	8 ¾ in	220 mm
22-	6	8 ¾ in	220 mm
3406	Sharp	8 ¾ in	220 mm
22-	2 Blunt		
3502	3 Blunt		
22-	4 Blunt		
3503	6 Blunt		
22-			
3504			

Retractors (Hook, Tracheal, Middle Ear)



Fomon Hook Retractor

CODE	DESCRIPTION	WIDTH	LENGTH
67-2025	Ball Tipped Prongs	13 mm	6 ¾ in 170 mm



Jackson Tracheal Retractor

CODE	DESCRIPTION	LENGTH
20 - 070 8	Double-Ended	6 ¾ in 170 mm



Endaural Retractor

CODE	DESCRIPTION	WORKING LENGTH	OVERALL LENGTH
61- 0 601	T-Model	3 in 76 mm	4 ¼ in 108 mm



House Hand Retractor

CODE	DESCRIPTION	LENGTH
61-0600	5 x 16 mm and 9 x 25 mm Blades	6 in 150 mm

Retractors (Middle Ear, Nasal)



Schuknecht Retractor

CODE	DESCRIPTION	PRONGS	LENGTH
24-2620	Double Curved Arms	3 x 3 Sharp	5 1/8 in 130 mm

Schuknecht Retractor

CODE	DESCRIPTION	PRONGS	DEEP	LENGTH
24-2625	Arms Curved Downwards	3 x 3 Sharp	17 mm	5 1/8 in 130 mm



61-0605

Bellucci-Wullstein Retractor

CODE	DESCRIPTION	BLADE	PRONGS	LENGTH
61-0605	Solid Blade on Right	10 x 20 mm	Two	5 in 125 mm
61-0606	Solid Blade on Left	20 mm	Two	5 in 125 mm
			Blunt	
			Blunt	

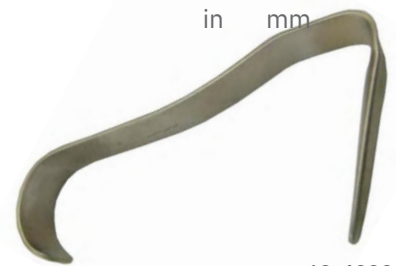

63-4022

Converse Nasal Retractor

CODE	LENGTH
63-4022	4 3/8 in 112 mm

EAR, NOSE & THROAT

Retractors (Tonsil & Laryngeal)



Hurd Dissector & Pillar Retractor

CODE	DESCRIPTION	LENGTH
72-2522	7 mm Dissector, 11 mm Retractor	8 ½ in 215 mm

Retractors (Nasal)



Cottle Nasal Retractor

CODE	WIDTH	PRONGS	LENGTH
67-2044	10 mm	4 Blunt	6 in 150 mm

Retractors (Orbital)



Sewall Orbital Retractor

CODE	BLADE	LENGTH
63-4003	7 x 52 mm	6 ¾ 170
63-4004	9 x 51 mm	in 6 mm
63-4005	11 x 50 mm	¾ in 170
		6 ¾ mm
		in 170
		mm

Retractors (Scalp)



Jansen Scalp Retractor

CODE	PRONGS	LENGTH
24-1310	3 x 3 Sharp	4 100
24-1320	3 x 3 Blunt	in mm
24-1321	4 x 4 Blunt	4 100
		in mm
		4 100

Retractors (Self-Retaining)



24-1011

Alm Retractor

CODE	PRONGS	LENGTH
24-1007	4 x 4	2 ¾ in 70 mm
24-1010	Sharp 4 x	4 in 100 mm
24-1008	4 Sharp 4	2 ¾ in 70 mm
24-1011	x 4 Blunt 4 x 4 Blunt	4 in 100 mm



Pediatric Weitlaner Retractor

CODE	PRONGS	LENGTH
61-0610	3 x 3 Blunt	4 ½ in 115 mm

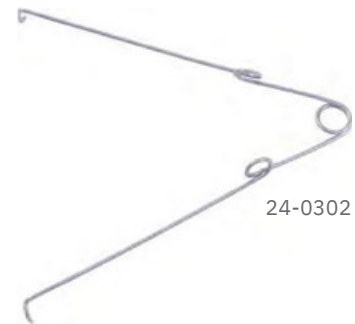

24-0302

Spring Retractor

CODE	PRONGS	DESCRIPTION	LENGTH
24-0301	1 x 1 Sharp		3 ½ 90 mm
24-0302	1 x 1 Sharp		in 4 115
24-0352	1 x 1 Sharp	With Ratchet	½ in mm
24-0303	3 x 3 Blunt		4 ⅙ 105
24-0304	3 x 3 Blunt		in 3 mm 90
			½ in mm
			4 ½ 115

Retractors (Self-Retaining)



24-2210

Weitlaner Retractor

CODE	PRONGS	LENGTH
24-	2 x 3,	4 ½ in 115 mm
2210	Sharp 3 x	5 ½ in 140 mm
24-	4, Sharp 3	6 ½ in 165 mm
2213	x 4, Sharp	8 in 200 mm
24-	3 x 4,	9 in 230 mm
2216	Sharp 3 x	4 ½ in 115 mm
24-	4, Sharp	5 ½ in 140 mm
2220	2 x 3,	6 ½ in 165 mm
24-	Blunt	8 in 200 mm
2224	3 x 4,	9 in 230 mm
24-	Blunt	
2211	3 x 4,	
24-	Blunt	
2214	3 x 4,	
24-	Blunt	
2217	3 x 4,	
24-	Blunt	
2221		
24-		
2225		



24-2614

Wullstein-Weitlaner Retractor

CODE	DESCRIPTION	PRONGS	DEEP	LENGTH
24-	Arms Angled	3 x 3 Sharp	12	5 ⅛ 130
2613	Downwards Arms	3 x 3 Blunt	mm	in 5 mm
24-	Angled Downwards		12	⅛ in 130
2614			mm	mm



Converse Alar Retractor

CODE	DESCRIPTION	WIDTH	LENGTH
67-2010	Double-Ended, Sharp	10 mm and 14 mm	4 ¾ in 120 mm

Retractors (Sinus & Nasal)

Cottle Alar Retractor



CODE	DESCRIPTION	LENGTH
67-2115	Tapered End 16 mm–13 mm	5 ½ in 140 mm

Converse Blade Retractor

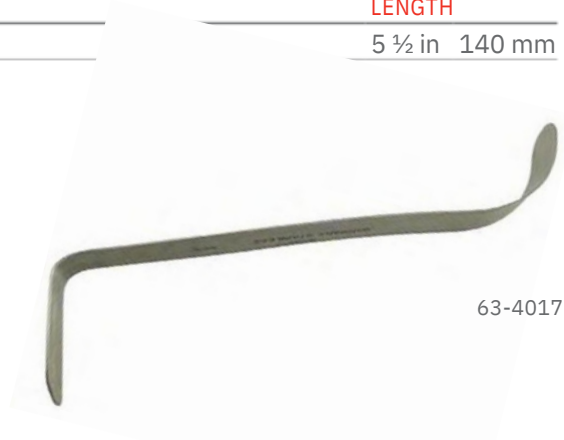

63-4017

CODE	DESCRIPTION	LENGTH
63-4017	9 x 18 mm	3 ¾ 95
63 - 4018	12 x 21 mm	in 3 mm
63 - 4019	12 x 38 mm	¾ in 95
63-4020	12 x 53 mm	3 ¾ mm
		in 3 95
		¾ in mm
		95
		mm



20-6453

Flexible Neck Retractor

CODE	PRONGS	LENGTH
20-	2 Sharp	6 ¼ 160
6452	3 Sharp	in 6 mm
20-	2 Blunt	¼ in 160
6453	3 Blunt	6 ¼ mm
20-		in 6 160
6552		¼ in mm
20-		160
6553		mm

Retractors (Thymus)



Lukens Thymus Retractor

CODE	DESCRIPTION	LENGTH
20 - 0707	Double-Ended	6 ¾ in 170 mm

Retractors (Thyroid)



Green Thyroid Retractor

CODE	DESCRIPTION	LENGTH
23 -3 512	Fenestrated Blade	8 ½ in 215 mm



Lahey Thyroid Retractor

CODE	DESCRIPTION	LENGTH
23-0306	6 mm x 3 mm	7 ¾ in 195 mm

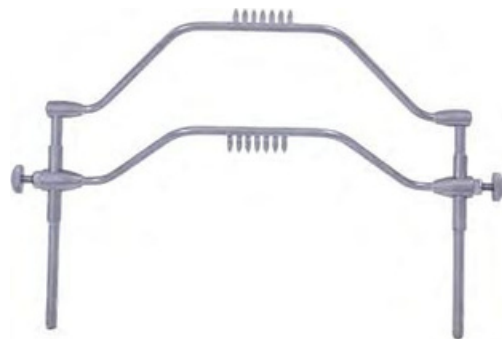

Mahorner Thyroid Retractor

CODE	DESCRIPTION	LENGTH
24-0888	7 Prong, 4 in, 100 mm Spread	10 ½ in 265 mm

Retractors (Uvula)

Goodyear Uvula Retractor

CODE	DESCRIPTION
71-6348	15 mm



LENGTH
7 ½ in 190 mm

Lothrop Uvula Retractor

CODE	DESCRIPTION
71-6360	17 x 20 mm



LENGTH
8 in 200 mm

Love Uvula Retractor

CODE	WIDTH	LENGTH
71-6318	18	6 ½ 165
71-6320	mm	in 6 mm
	20	½ in 165
	mm	mm



71-6318

Retractors (Vein)

Cushing Vein Retractor

CODE	WIDTH	LENGTH
20-	8 mm	8 in 200 mm
1708	10	8 in 200 mm
20 -17	mm	8 in 200 mm
10 20	12	8 in 200 mm
-17 12	mm	8 in 200 mm
20 -17	14	8 in 200 mm
14 20	mm	
-17 16	16	



20-1708

Retractors (Cheek & Tongue)



University of Minnesota Cheek Retractor & Tongue Depressor

CODE	LENGTH
72-0210	5 ½ in 140 mm

Rongeurs (Bone)

Beyer Bone Rongeur

CODE	DESCRIPTION	JAWS	LENGTH
30-7102	Slender	2 mm	6 ¾ in 170 mm
30-7103	Slender	3 mm	7 in 175 mm



30-7103

Friedman Bone Rongeur

CODE	DESCRIPTION	JAWS	LENGTH
30-0514	Delicate	4 x 11 mm	5 ½ in 140 mm
30-0516	Cur ved	11 mm	5 in 140 mm



Tip



30-0514

Micro Friedman Rongeur

Very Delicate

CODE	DESCRIPTION	JAWS	LENGTH
30-0201	Straight	1.3 mm	5 ½ in 140 mm
30-0203	Straight	2 mm	5 in 140 mm
30-0202	Cur ved	1.3 mm	5 ½ in 140 mm
30-0204	Cur ved	2 mm	5 ½ in 140 mm



30-0202

Rongeurs (Bone)

Jansen Bone Rongeur

CODE	DESCRIPTION	JAWS	LENGTH
30-5018	Straight	4	7 in 175
30-5118	Curved	mm	7 in mm
		4	175
		mm	mm



31-5018

Ruskin-Mini Bone Rongeur

Double Action

CODE	DESCRIPTION	JAWS	LENGTH
31-0402	Straight	2	6 150
31-0502	Straight	mm	in mm
31-0403	Curved	2	6 150
31-0503	Curved	mm	in mm
		3	6 150
		mm	in mm
		3	6 150
		mm	in mm



31-0403

Rongeurs (Kerrison)

Kerrison Rongeur

CODE	DESCRIPTION	LENGTH
62-6203	#0 3 mm	6 ¾ in 170 mm
62-6204	#1 Bite 4	6 ¾ in 170 mm
62-6205	#2 mm Bite	6 ¾ in 170 mm
62-6206	#3 5 mm	6 ¾ in 170 mm
	Bite 6	
	mm Bite	



62-6203

Kerrison-Costen Rongeur

90° Bite on Curved Shaft

CODE	SHAFT	LENGTH
6 3 - 5010102	mm 3 x 3 mm	5 ½ in 140 mm



Rongeurs (Synovectomy)

Kleinert-Kutz Synovectomy Rongeur

Single Action

CODE	DESCRIPTION	JAW WIDTH	LENGTH
30-7613	Slightly Curved	2 mm	5 ½ in 140 mm
30-7614	Fully Curved	2 mm	½ in 140 mm



Kleinert-Kutz Synovectomy Rongeur

Double Action

CODE	DESCRIPTION	JAW WIDTH	LENGTH
31-0552	Slightly Curved	2 x 13 mm	6 in 150 mm
31-0553	Slightly Curved Fully	3 x 8.0mm	6 in 150 mm
31-0554	Curved		150 mm



Beyer Rongeur

Double Action

CODE	DESCRIPTION	JAW WIDTH	LENGTH
31-1003	Curved	3 mm	7 ½ in 180 mm
31-1104	Curved	4 mm	7 ½ in 180 mm



Blumenthal Rongeur

CODE	DESCRIPTION	JAW WIDTH	LENGTH
30-2547	30° Angle	4 mm	6 ¼ in 160 mm
30-2545	45° Angle	4 mm	6 ¼ in 160 mm
30-2546	90° Angle	4 mm	6 ¼ in 160 mm



Rongeurs (Synovectomy)

Citelli Rongeur

Serrated Bite

CODE	DESCRIPTION	BITE	LENGTH
62-6251	9.5 mm	#1, 1.5 x 4 mm	5 ½ 140
62-6252	Shaft 8.5 mm Shaft	#2, 2.5 x 4 mm	in 5 mm ½ in 140 mm



62-6252

Goldman-Kazanjian Rongeur

CODE	DESCRIPTION	JAW WIDTH	LENGTH
30-8000	Straight Handle	17 mm	7 in 175 mm



Jansen Rongeur

CODE	DESCRIPTION	JAW WIDTH	LENGTH
30-7959	Bayonet Shaped	4 mm	6 ¾ in 170 mm



Juers-Lempert Rongeur

Jaws on Curved Handles

CODE	HANDLE	JAW WIDTH	LENGTH
30-7621	Straight	3 mm Wide	7 ½ in 190 mm

Rongeurs (Synovectomy)

Leksell Rongeur

Double Action

CODE	DESCRIPTION	JAW WIDTH	LENGTH
31-5103	Lightly Curve	3	9 228
31-5105	Lightly Curve	mm	in mm
31-5108	Lightly Curve	5	9 228
31-5303	Fully Curved	mm	in mm
31-5305	Fully Curved	8	9 228
31-5308	Fully Curved	mm	in mm
		3	9 228
		mm	in mm
		5	9 228
		mm	in mm
		8	9 228
		mm	in mm



Lempert Rongeur

2.5 mm Jaws

CODE	DESCRIPTION	HANDLE	LENGTH
30-7620	Straight	Slender Pattern	6 ¼ 160 mm
30-7624	Straight	Slender Pattern	in 7 190 mm
30-7619	Straight	Heavy Pattern	½ in 190 mm
30-7623	Curved	Slender Pattern	7 ½ 185 mm
30-7625	Curved	Slender Pattern	in 7 190 mm
30-7622	Strong Curved	Slender Pattern	¼ in 160 mm
			7 ½
			in
			6 ¼
			in



Zaufel-Jansen Rongeur

Double Action

CODE	DESCRIPTION	WIDTH	LENGTH
31-1105	Cur ved	5 mm	7 ⅞ in 180 mm



Saws (Nasal)

Joseph Bayonet Saw

CODE	DESCRIPTION
67-6010	Straight
67-6011	Angled Left
67-6012	Angled Right



LENGTH
7 ¼ 185
in 7 mm
¼ in 185
7 ¼ mm
in 185
mm

Maltz-Joseph Saw

CODE	DESCRIPTION	WORKING LENGTH
67-6021	Angled Left	3 ¼ in 83 mm 3 ¼
67-6022	Angled Right	in 83 mm



Scissors (Alligator)

Bellucci Alligator Scissors

CODE	DESCRIPTION	SHAFT	BLADES	LENGTH
61-0706	Straight	74 mm	5 mm	5 ¼ 135
61-0710	Straight	77 mm	7 mm	in 5 mm
61-0710E	Straight , Ebonized	77 mm	7 mm	¼ in 135
61-0707	Curved Left	74 mm	5 mm	5 ¼ mm
61-0704	Curved Left	75 mm	7 mm	in 5 135
61-0708	Curved Right	74 mm	5 mm	¼ in mm
61-0705	Curved Right	75 mm	7 mm	5 ¼ 135
61-0708E	Curved Right, Ebonized	74 mm	5 mm	in mm

5 ¼ 135
in mm
5 ¼ 135
in mm
5 ¼ 135
in mm
135
mm



Scissors (Alligator)

Luetje Alligator Scissors

90 mm Shaft

CODE	DESCRIPTION	BLADES	LENGTH
61-0712	Straight	4 mm	5 ¼ in 135 mm



Scissors (Dissecting)

Brown Dissecting Scissors

Narrow Blades

CODE	DESCRIPTION	LENGTH
04-5075	Straight	5 ¾ in 145
04 - 5076	Curved	5 ½ in 140 mm



Kaye Dissecting Scissors

Serrated

CODE	DESCRIPTION	LENGTH
67-5120	Straight	4 ¾ in 108 mm
67-5121	Curved	4 ¾ in 108 mm



Scissors (Dorsal)

Converse Dorsal Scissors

CODE	DESCRIPTION	LENGTH
67-5511	Serrated Blades	6 ½ in 165 mm



Cottle Dorsal Scissors

Angled Handle

CODE	DESCRIPTION	LENGTH
67-5316	Heavy Pattern	6 in 150 mm

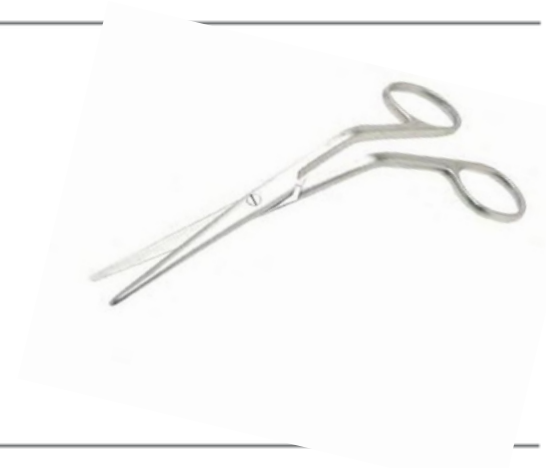

Cottle Dorsal Scissors

Angled Handle

CODE	DESCRIPTION	LENGTH
32-583	Tungsten Carbide	6 ¼ in 160 mm



Dorsal Scissors

CODE	DESCRIPTION	LENGTH
67-5508	Straight, Blunt	4 ¾ in 120 mm



Scissors (Dorsal)

Fomon Dorsal Scissors

Fine Tungsten Carbide Blade, Serrated Lower Blade

CODE	DESCRIPTION	LENGTH
32-572	Angled Handle	5 $\frac{5}{16}$ in 137 mm



Fomon Dorsal Scissors

Serrated Blades

CODE	DESCRIPTION	LENGTH
67-5313	Angled Handle	6 $\frac{1}{2}$ in 165 mm



Ceramic Coated Cottle Dorsal Scissors

Razor Edges and Micro Serrations

CODE	DESCRIPTION	LENGTH
227.53.36	Ceramic Coated	6 $\frac{1}{4}$ in 160 mm



Converse Double Edge Scissors

CODE	DESCRIPTION	LENGTH
67-5013	Straight	5 $\frac{1}{2}$ in 130 mm

Scissors (Face Lift)

Judy Friedman Face Lift Scissors

Curved, Sharp Outer Edges

CODE	DESCRIPTION	LENGTH
67-	Slender Pattern	9 7/8 in 250 mm
5154	Heavy Pattern	6 3/4 in 170 mm
67-		
5155		

Scissors (Ganglion)

Adson Kelly Ganglion Scissors

Sharp Outer Edges

CODE	DESCRIPTION	LENGTH
04-	Straight	6 1/4 160
5416 04	Curved	in 6 mm
- 5 516		1/4 in 160 mm



04-5516

Scissors (Iris)

Knapp Iris Scissors

CODE	DESCRIPTION	LENGTH
54-	Straight Sharp/Blunt	4 102
6524	Straight Blunt/Blunt	in mm
54-	Cur ved Sharp/Blunt	4 102
6526	Cur ved Blunt/Blunt	in mm
54-		4 102
6525		in mm
54-		4 102
6527		in mm



54-6524

Scissors (Lower Lateral)

Cinelli Lower Lateral Scissors

CODE	DESCRIPTION	LENGTH
67-5211	Strong Curve	4 ½ in 115 mm



Fomon Lower Lateral Scissors

CODE	DESCRIPTION	LENGTH
67-5212	Strong Curve	5 ¾ in 137 mm



Scissors (Micro-Laryngeal)

Jako Micro-Laryngeal Scissors

CODE	DESCRIPTION	LENGTH
74-5932	Straight, Vertical Cut	9 ¼ in 235 mm
74-5931	Angled Up	9 mm
74-5934	Curved Left, Vertical Cut	¼ in 235 mm
74-5935	Curved Right, Vertical Cut	9 ¼ in 235 mm

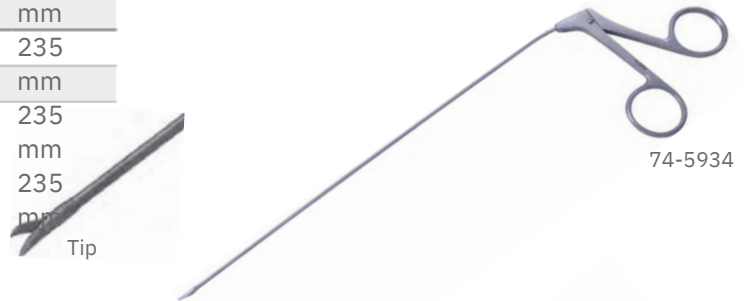

Jako-Kleinsasser Micro-Laryngeal Scissors

CODE	DESCRIPTION	LENGTH
74-5974	Straight	8 ⅝ in 219 mm
74-5977	Angled Left	8 ⅝ in 219 mm
74-5976	Angled Right	8 ⅝ in 219 mm
74-5975	Angled Up	8 ⅝ in 219 mm



Scissors (Micro-Laryngeal)

Kleinsasser Micro-Laryngeal Scissors

CODE	DESCRIPTION	BLADES	LENGTH
74-6028	Straight	4 mm	10 ¾ in 270 mm
74-6035	Straight, Serrated	4 mm	10 ¾ in 270 mm
74-6028	Curved Left	4 mm	10 ¾ in 270 mm
74-6036	Curved Left, Serrated	4 mm	10 ¾ in 270 mm
74-6030	Curved Right	4 mm	10 ¾ in 270 mm
74-6037	Curved Right, Serrated	4 mm	10 ¾ in 270 mm
74-6031	Curved Up	4 mm	10 ¾ in 270 mm
74-6038	Curved Up, Serrated	4 mm	10 ¾ in 270 mm

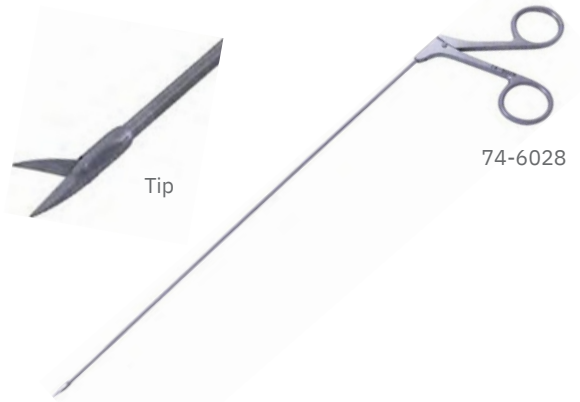

Shea-Bellucci Scissors

Extra Narrow

CODE	DESCRIPTION	BLADES	LENGTH
61-0709	Straight	8 mm	5 ¼ in 135 mm



Scissors (Miniature)

Bellucci Miniature Scissors

CODE	DESCRIPTION	BLADES	SHAFT	LENGTH
61-0713	Straight	4 mm Sharp	75 mm	5 ¼ in 135 mm



Scissors (Nasal)

Converse-Wilmer Nasal Scissors

CODE	DESCRIPTION	LENGTH
67-5513	Angled on Flat	4 in 135 mm



Fomon Nasal Scissors

CODE	DESCRIPTION	LENGTH
67-5112	Curved	5 ¼ in 125 mm



Goldman Nasal Scissors

Saber Back, Semi-Sharp Outer-

CODE	DESCRIPTION	LENGTH
67-5506	Curved	5 ¾ in 145 mm



Knight Nasal Scissors

DESCRIPTION	CODE	LENGTH
Standard Pattern	67-5503	7 in 175 mm



Jackson Nasal Bone Scissors

Angled Blade, Serrated

CODE	DESCRIPTION	LENGTH
67-5516	Heavy Pattern	8 ½ in 215 mm



Scissors (Nasal)

Jameson Tenotomy Scissors

CODE	DESCRIPTION	LENGTH
80 - 67 16	Curved	6 ¼ in 156 mm



Joseph Scissors

CODE	DESCRIPTION	LENGTH
80-5015	Straight	5 ¾ in 145 mm



Scissors (Razor Edge)

Kaye Scissors

Razor Edge

CODE	DESCRIPTION	LENGTH
80-4200	Curved	4 ½ in 115 mm



Ragnell Scissors

Beveled Dissecting Tips

CODE	DESCRIPTION	LENGTH
80-4905	Curved	5 ¼ in 133 mm



Scissors (Removal, Rhinoplasty, Septum)

Joseph Rhinoplasty Scissors

CODE	DESCRIPTION	BLADE	LENGTH
04-	Straight	Sharp/Sharp	6 ¼ in 160 mm
5015	Straight	Sharp Outer Blade	6 ¼ in 160 mm
04-	Curved	Sharp/Sharp	6 ¼ in 160 mm
5016 04	Curved	Sharp Outer Blade	6 ¼ in 160 mm
-5115			
04	-		
5116			



04-5115

Becker Septum Scissors

CODE	DESCRIPTION	LENGTH
67-5505	Double Action, Angled Handles, Serrated	7 ¼ in 185 mm



Caplan Septum Scissors

CODE	DESCRIPTION	LENGTH
67-5371	Double Action, Serrated	7 ¾ in 197 mm



Scissors (Septum, Serrated, Sinus)

Goldman Septum Scissors

CODE	DESCRIPTION	LENGTH
67-5509	Angled Handle, Serrated	5 ⅞ in 150 mm

Scissors (Septum, Serrated, Sinus)

Joseph Scissors with Micro Serrations

CODE	DESCRIPTION	LENGTH
204.50.15	Straight, Gold Screw	5 ¾ in 145 mm
204.51.15	Curved, Gold Screw	5 ¾ in 145 mm



204.51.15

Sinus Scissors

Pediatric

CODE	DESCRIPTION	SHAFT	BLADES	LENGTH
63-7700	Straight	90 mm	5	5 ¾ in 145 mm
63-7701	Curved Left	90 mm	5	5 ¾ in 145 mm
63-7702	Curved Right	90 mm	5	5 ¾ in 145 mm



63-7701

Sinus Scissors

Adult

CODE	DESCRIPTION	SHAFT	BLADES	LENGTH
63-7705	Straight, Serrated	155 mm	11 mm	8 ¾ in 222 mm
63-7706	Curved Left, Serrated	155 mm	11 mm	8 ¾ in 222 mm
63-7707	Curved Right, Serrated	155 mm	11 mm	8 ¾ in 222 mm



Tip



63-7706

Scissors (Strabismus, Suture Carrying)

Littler Suture Carrying Scissors

CODE	DESCRIPTION	LENGTH
60-1868	Curved, Cutting Blades with Hole	4 ¾ in 120 mm



Scissors (Tenotomy)

Jamison Metzenbaum Tenotomy Scissors

CODE	DESCRIPTION	LENGTH	
37-4033	Cur ved Cur	6	152
37-4031	ved Cur ved	in	mm
37-4027		8	203
		in	mm
		9	229
		in	mm



37-4027

Razor Edge Scissors with Micro Serrations & Gold Screw

CODE	DESCRIPTION	LENGTH	
214.67.12	Cur ved Cur	4 ¾ in	120
214.67.13	ved Cur ved	5 ½ in	mm
214.67.16		6 ¼ in	130
			mm
			158
			mm



214.67.16

Potts Tenotomy Scissors

CODE	DESCRIPTION	LENGTH	
37-4032	Curved	6 in	152 mm

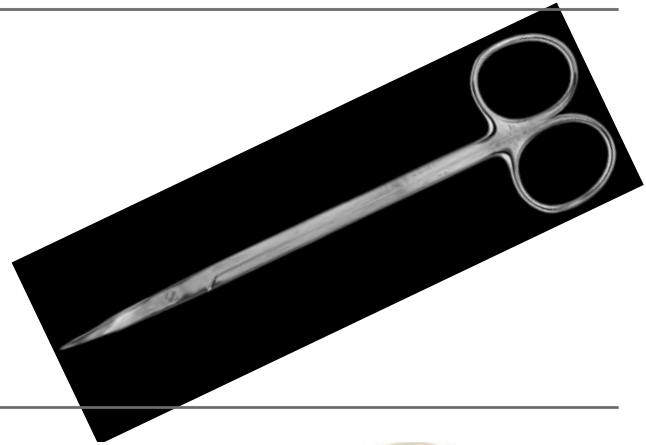

Stevens Tenotomy Scissors

CODE	DESCRIPTION	LENGTH	
54-6520	Straight	4 ½ in	105 mm
54-6522	Straight Cur	4 ¾ in	118 mm
54-6521	ved Cur ved	4 ¾ in	105 mm
54-6523		4 ¾ in	118 mm



54-6520

Scissors (Tissue and Gum, Tonsil)

Fox Tissue and Gum Scissors

Tungsten Carbide Edges

CODE	DESCRIPTION	LENGTH
32-941	Straight	5 1/8 in 130
32-940	Cur ved	5 1/8 in mm 130 mm



32-941

Boettcher Tonsil Scissors

CODE	DESCRIPTION	BLADE	LENGTH
54-1081	Cur	Double-Edged, Angled on Side	7 1/4 in 184
72-4525	ved	Double - Edged	7 3/8 in mm 187 mm



72-4525

Dean Tonsil Scissors

CODE	DESCRIPTION	BLADE	LENGTH
72-4550	Angled	One Serrated	6 3/4 in 170 mm



Prince Tonsil Scissors

CODE	DESCRIPTION	BLADE	LENGTH
72-4520	Curved	Slender	7 5/16 in 186 mm



Scissors (Turbinate)

Gorney Turbinate Scissors

Serrated

CODE	DESCRIPTION	LENGTH
67-5515	Double Action, 33 mm Jaws	8 in 200 mm

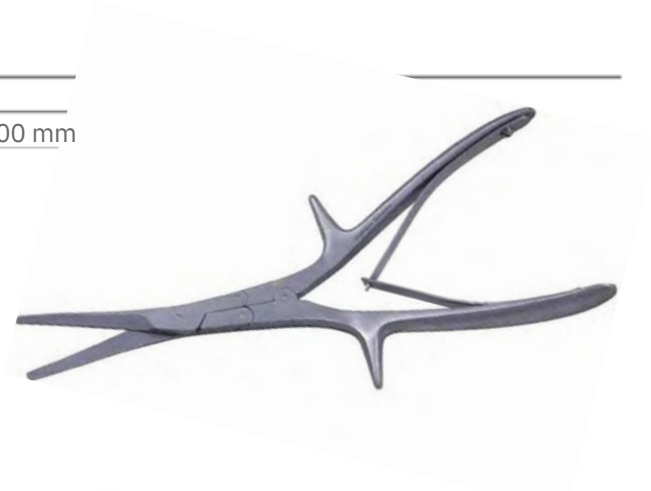

Seiler Turbinate Scissors

CODE	DESCRIPTION	LENGTH
67-5504	Heavy Pattern, Angled on Side	6 ¼ in 158 mm



Brophy Scissors

CODE	DESCRIPTION	LENGTH
04 -2014	Straight, Sharp/Sharp	5 ½ 140
04 -2 114	Curved, Sharp/Sharp	in 5 mm
		½ in 140
		mm

Jameson Reynolds Scissors

Serrated

CODE	DESCRIPTION	LENGTH
85-2121	Cur	5 ¼ 133
85-2123	ved	in 6 mm
85-2125	Cur	¼ in 158
	ved	7 in mm
	Cur	177
	ved	mm



85-2121

Scissors

Jameson Reynolds Scissors

Serrated with Black Handles

CODE	LENGTH
86 - 67	5 ¼ 133
13 86 -	in 6 mm
67 16	¼ in 158 mm



86-6716

Joseph Scissors

Serrated with Black Handles

CODE	DESCRIPTION	LENGTH
86-5015	Straight	6 152
86-5115	Cur ved	in mm
		6 152
		in mm



86-5115

Joseph Scissors

Serrated

CODE	DESCRIPTION	LENGTH
85-	Straight	6 152
2063	Curved	in mm
85-		6 152
2064		in mm



85-2064

Ragnell Dissecting Scissors

Beveled Dissecting Tip

CODE	DESCRIPTION	LENGTH
67-5507	Curved	5 in 127 mm



Snares (Nasal, Snare Wire, Tonsil)

Bruening Nasal Snare

CODE	DESCRIPTION	LENGTH
66 -1510	Complete Bayonet Style W/ Snare & Stylet	8 in 203 mm
66 -1512-3	Size 0 0.30 mm	Cut & Formed
66 -1512-4	Size 1 0.33 mm	Cut & Formed
66-1512-5	Size 2 0.40 mm	Cut & Formed
66 -1512-6	Size 3 0.50 mm	Cut & Formed

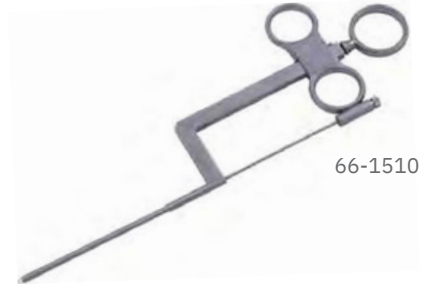

66-1510

Sage Tonsil Snare

CODE	DESCRIPTION	LENGTH
72-6011	Sage Tonsil Snare Instrument	11 in 280 mm
72-6012-6	0.35 mm	
72-6012-7	0.40 mm	
72-6012-8	0.45 mm	
72-6012-9	0.50 mm	



72-6011

Tyding Tonsil Snare

CODE	DESCRIPTION	LENGTH
72-		9 ½ in 241 mm
5051	Prepared Snare Wire	
72-	#7 Prepared Snare	
6515	Wire #8 Prepared	
72-	Snare Wire #9	



72-5051

Speculums (Middle Ear, Nasal)

6517

Shea Ear Speculum Holder

CODE	LENGTH
62-0380	11 ¾ in 300 mm



Cottle Nasal Speculum

Self-Retaining, Narrow Tapered Blades

CODE	BLADES	LENGTH
67-0230	30 mm	5 ½ in 140 mm
67-0235	35 mm	5 ½ in 140 mm
67-0255	55 mm	5 ½ in 140 mm
67-0270	70 mm	5 ½ in 140 mm
67-0275	75 mm	5 ½ in 140 mm
67-0290	90 mm	5 ½ in 140 mm



67-0235

Speculums (Middle Ear, Nasal)

Halle Nasal Speculum

CODE	BLADE	LENGTH
79-	32 mm	6 in 152 mm
6669	32 mm	6 ¼ in 160 mm
63-		
6235		



79-6669

Speculums (Nasal)

Hartmann-Halle Nasal Speculum

CODE	DESCRIPTION	BLADES	LENGTH
66-0301	Small	25 mm	6 152
66-0302	Medium	30 mm	in mm
66-0303	Large	32 mm	6 152
			in mm
			6 152
			in mm



66-0303

Tieck Infant Nasal Speculum

CODE	BLADES	LENGTH
63-6250	18 mm	5 ½ in 140 mm



Vienna Nasal Speculum

CODE	BLADE LENGTH	LENGTH
63-6241	24 mm 27	5 ¼ 133
79-6675	mm 28 mm	in 5 mm
79 -	30 mm 32	¼ in 133
6676 6	mm 32 mm	5 ¼ mm
3 - 6242	34 mm	in 5 133
63-6243		¼ in mm
79-6677		5 ¼ 133
63-6244		in 5 mm
		¼ in 133



79-6676

Speculums (Septum)

Cottle Septum Speculum

CODE	DESCRIPTION	BLADES	LENGTH
6 3 - 6270	Self-Retaining, Thin Modified	50 mm	6 in 152 mm



Killian Septum Specula & Killian Septum Speculum

Self-Retaining

CODE	BLADES	LENGTH
79	51 mm	5 ¼ 133
-7011	63 mm	in 5 mm
79	76 mm	¼ in 133
-7012	51 mm	5 ¼ mm
79	64 mm	in 6 133
-7013	76 mm	in mm
63-6265	90 mm	6 in 152
63-6266		6 in mm
6 3 -		6 in 152



79 -7011

Septum Speculum

Self-Retaining, Very Narrow Blade, Ebony Finish

CODE	BLADES	LENGTH
6 3 -2	35 mm	5 ½ 139
181 63-	50 mm	in 5 mm
2182	75 mm	½ in 139
63-	90 mm	5 ½ mm
2183		in 5 139
63-		½ in mm
2184		139 mm



63-2181

Tebbetts Speculum

CODE	DESCRIPTION	LENGTH
67-0242	Thin Blades 1 ¼ in (45 mm)	6 in 152 mm



Speculums (Septum)



61-0932

Farrior Speculum

CODE	SIZ	DESCRIPTION	DISTAL END
61- 0917	E	Oval Regular End Oval	4.5 x 6 mm
61- 0918	#1	Regular End Oval Regular	5.5 x 7 mm
61- 0919	#2	End Oval Regular End Oval	6.5 x 8 mm
61-0920	#3	Regular End Oval Regular	7.5 x 9 mm
61-0921	#4	End Oval Regular End	8 x 10 mm
61-0922	#5	Ebonized Oval Regular	9 x 11.25 mm
61-0923	#6	End Ebonized Oval	10 x 12.5 mm
61-	#7	Regular End	4.5 x 6 mm
0917E	#1	Ebonized Oval Regular	5.5 x 7 mm
61- 0918	#2	End	6.5 x 8 mm
E	#3	Ebonized Oval Regular	7.5 x 9 mm
61-	#4	End	8 x 10 mm
0919E	#5	Ebonized Oval Regular	9 x 11.25 mm
61-	#6	End	10 x 12.5 mm
0920E	#7	Ebonized Oval Regular	
61- 092		End	
1E		Ebonized Oval Regular	
61-		End	
0922E			
61-			
0923E			



61-0910

Farrior Speculum

CODE	SIZ	DESCRIPTION	DISTAL END
61- 0910	E	Round Regular End Round	5 mm 6
61- 0911	#1	Regular End Round Regular	mm 7 mm
61- 0912	#2	End Round Regular End	8 mm 9
61- 0913	#3	Round Regular End Round	mm 10
61- 0914	#4	Regular End Round Regular	mm 10.5
61-0915	#5	End Ebonized, Round	mm 5 mm
61- 0916	#6	Regular End Ebonized,	6 mm
61-	#4	Round Regular End	7 mm
0910E	#1	Ebonized, Round Regular	8 mm
61-	#2	End	9 mm
0911E	#3	Ebonized, Round Regular	10 mm
61-	#4	End	10.5 mm
0912E	#5	Ebonized, Round Regular	
61- 0913	#6	End	
E	#4	Ebonized, Round Regular	
61-		End	

Speculums (Septum)

Farrior Speculum

CODE	SIZ	DESCRIPTION	DISTAL END
61- 0924	E	Round Oblique End Round	6 mm 7
61-0925	#1	Oblique End Round Oblique	mm 8 mm
61-0926	#2	End Round Oblique End	9 mm 10
61-0927	#3	Round Oblique End Round	mm 11
61-0928	#4	Oblique End Round Oblique	mm 12
61-0929	#5	End Ebonized Round Oblique	mm 6 mm
61-0930	#6	End Ebonized Round Oblique	7 mm 8
61-	#7	End	mm 9 mm
0924E	#1	Ebonized Round Oblique End	10 mm 11
61-	#2	Ebonized Round Oblique End	mm 12
0925E	#3	Ebonized Round Oblique End	mm
61-	#4	Ebonized Round Oblique End	
0926E	#5	Ebonized Round Oblique End	
61-	#6		
0927E	#7		



61-0924E

61-
0928E
61-

Boucheron Speculum

Round, Chrome Plated

CODE	SIZ	DISTAL END
61-0901	E	3 mm 4
61-0902	#1	mm 4.5
61-0903	#2	mm 5 mm
61-0904	#3	5.5 mm 7
61-0906	#4	mm 8.0
61-0907	#5	mm 9.5
61-0908	#6	mm
61-0909	#7	
	#8	



61-0901

Gruber Speculum

Round, Chrome Plated

CODE	DISTAL END	LENGTH
61-	3 mm 3.5	33 mm
0979	mm 4 mm	35 mm
61-	5 mm	35 mm
0965		37 mm
61-		
0966		
61-		
0967		



61-0979

Speculums (Ear)

Gruber Speculum

Oval, Chrome-Plated

CODE	DISTAL END	LENGTH
61-	2 x 3	33 mm
0975	mm 3 x	33 mm
61-	4 mm 3	35 mm
0968	x 5 mm	37 mm
61- 097	3 x 6	42 mm
3 61-	mm 5 x	42 mm
0974	6 mm 6	42 mm
61-	x 7 mm	



61-0973

Hartmann Speculum

Round, Chrome-Plated

CODE	DISTAL END	LENGTH
61- 097	2.5	35
0962	mm 4	mm
61-	mm 5	35
0953	mm 6	mm
61-	mm 7	35
0954	mm	mm
61-		35



61-0955

Hartmann Speculum

Oval, Chrome-Plated

CODE	DISTAL END	LENGTH
61-	2.5 x 3	35
0963	mm 4.5 x	mm
61-	5 mm 5.5	35
0958	x 6 mm	mm
61-	6.5 x 7	35
0959	mm 7.5 x	mm
61-	8 mm	35



61-0958

Toybee Speculum

Round, Chrome Plated

CODE	DISTAL END	LENGTH
61-	2 mm	35
0950	End 4	mm
61-	mm End	35
0941	5 mm	mm
61-	End 6	35
0942	mm End	mm
61-	7 mm	35
0943	End	mm
61-		35
0944		mm



61-0942

Speculums (Ear)

Toybee Speculum

Oval, Chrome Plated

CODE	DISTAL END	LENGTH
61-	2.5 x 3.5 mm	35 mm
0939	4.5 x 5 mm	35 mm
61-	5.5 x 6 mm	35 mm
0946	6.5 x 7 mm	35 mm
61-	7.5 x 8 mm	35 mm
0947		
61-		
0948		
61-		
0949		



61-0949

Spreaders (Middle Ear)

Guilford-Wright Loop Spreader

CODE	JAWS	SHAFT
61- 0137	Pointed Serrated 7.0 mm	75 mm



Tip

EAR, NOSE & THROAT

Suction Tubes (Ear, Middle Ear)

Bellucci Ear Suction Tube

CODE	DESCRIPTION	TIP LENGTH	LENGTH
61-	18 Gauge Tip	1 3/8 35	6 152
1010	20 Gauge Tip	in 1 mm	in mm
61-	21 Gauge Tip	3/8 in 35	6 152
1011	22 Gauge Tip	1 3/8 mm	in mm
61-	24 Gauge Tip	in 1 35	6 152
1012	26 Gauge Tip	3/8 in mm	in mm
61-	Bellucci Tube Only	1 3/8 35	6 152
1013		in 1 mm	in mm
61-		3/8 in 35	6 152
1014		mm	in mm
61-		35	6 152
1015		mm	in mm
61-		6	152



61-1014

Suction Tubes (Ear, Middle Ear)

Rosen Suction Tube

CODE	DESCRIPTION	LENGTH	
61-1034	14 Gauge	2	50
61-1035	15 Gauge	in	mm
61-1036	16 Gauge	2	50
61-1037	17 Gauge	in	mm
61-1038	18 Gauge	2	50
61-1039	19 Gauge	in	mm
61-1040	20 Gauge	2	50
61-1041	22 Gauge	in	mm
61-1042	24 Gauge	2	50
61-1043	26 Gauge	in	mm



61-1034

House Cut-Off Adapter

CODE	DESCRIPTION	LENGTH
61-1045	For Use with Rosen Suction	2 in 50 mm



Suction Tubes (Aspirating)

Jackson "Velvet Eye" Aspirating Tube

CODE	DESCRIPTION	DIAMETER	LENGTH
72-6046	12 French	4 mm	4 10 x 250 mm
74-6455	12 French	mm	20 x 500 mm
74-6457	"Velvet Eye"		40 x 600 mm



74-6455

Suction Tubes (Aspirating)

Jako Suction Tube

CODE	DESCRIPTION	HANDLE	LENGTH
74-5005	#00	5	9 in 230 mm 9
74-5006	#0	French	in 230 mm 9
74-5007	#1	6	in 230 mm
		French	
		7	
		French	



Suction Tubes (Laryngeal, Septum)

Kleinsasser Laryngeal Suction Tube

CODE	DESCRIPTION	LENGTH
74-5002	2.5 mm	9 in 230 mm



Gorney Septum Suction Tube

CODE	DESCRIPTION	LENGTH
63-7570	2 mm, with Stylet	8 ½ in 215 mm



Syringes (Ear)

Ear Syringe

CODE	DESCRIPTION
61-	Bulbous Tip
2001	Bulbous Tip
61-	Shield Tip
2005	Tapered Tip
61-	
2006	
61-	
2004	



Tracheal Tubes (Laryngectomy)

Martin Laryngectomy Tube

CODE	DESCRIPTION
72-6053	Size 8, Stainless Steel
72-6054	Size 10, Stainless Steel
72-6055	Size 12, Stainless Steel



72-6054

Trocars (Sinus & Nasal)

Van Alyea Antrum Trocar

CODE	DESCRIPTION
66 - 6047	Trocar Tip

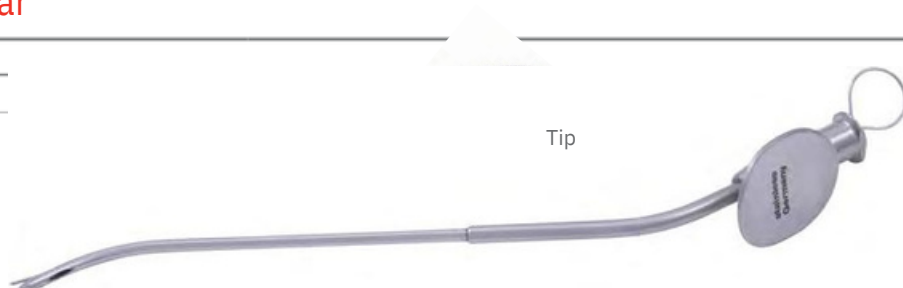

Tip

