



Thoracic

| | |
|----------------|-----|
| Artery Clamps | 212 |
| Clamps | 214 |
| Bulldog Clamps | 219 |
| Scissors | 220 |
| Needle Holders | 221 |
| Retractors | 222 |
| Rib Spreaders | 223 |
| Rib Shears | 226 |
| Lung Forceps | 226 |
| Elevators | 227 |
| Miscellaneous | 227 |

Website: www.tetraind.com

Email: info@tetraind.com

WhatsApp: +92 329 7598399

Address: Shahab Pura 51310
Sialkot pakistan

An Overview On Atraumatic Jaws

Also known as non-traumatic, atraumatic jaws will be mainly found in delicate surgery areas such as vascular and cardiothoracic. The design is such, that the surface area gripped is reduced, ensuring less trauma without the loss of grip.

Atraumatic jaws are available as straight or curved.

Atraumatic Jaw, Straight



Atraumatic Jaw, Curved



Cooley Artery Clamps

Box joint, atraumatic, curved

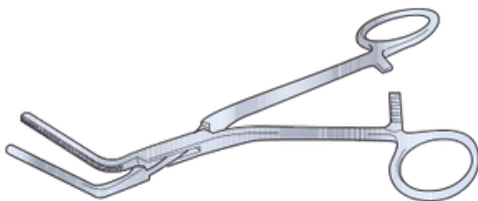

| Code | Description |
|-----------|-------------|
| SC-GI/071 | 160mm long |
| SC-GI/072 | 200mm long |

Large, strongly curved 90°

| Code | Description |
|-----------|-------------|
| SC-GI/074 | 140mm long |

Large, curved 60°

| Code | Description |
|-----------|-------------|
| SC-GI/073 | 150mm long |

Curved 30°

| Code | Description |
|-----------|-------------|
| SC-GI/075 | 160mm long |

DeBakey Bainbridge Clamps

Box joint, atraumatic, haemostatic

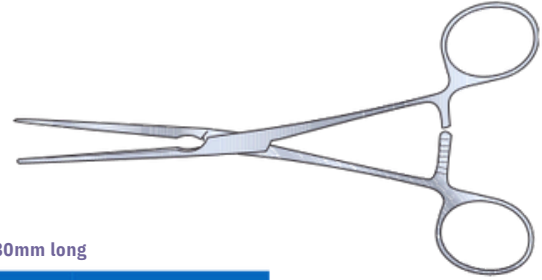

180mm long

| Code | Description |
|--------|-------------|
| SC- | Straight |
| GI/078 | Curved |

SC-
GI/077

DeBakey Bainbridge Clamps

Box joint, atraumatic

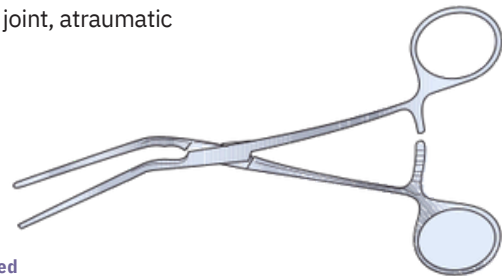

Curved

| Code | Description |
|-----------|-------------|
| SC-GI/079 | 165mm long |

DeBakey Bainbridge Clamps

Box joint, atraumatic, haemostatic

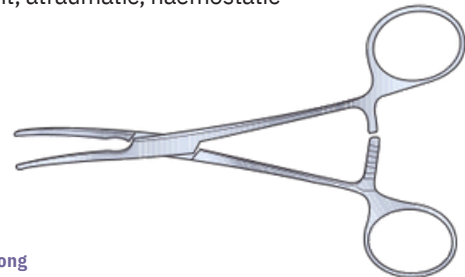

155mm long

| Code | Description |
|--------|-------------|
| SC- | Curved |
| GI/105 | Straight |

SC-
GI/106

DeBakey Clamps

Box joint, atraumatic

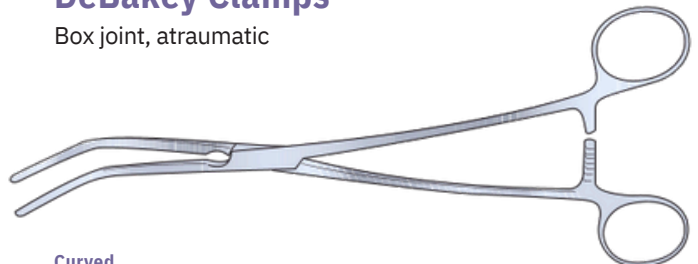

Curved

| Code | Description |
|-----------|-------------|
| SC-GI/086 | 230mm long |

DeBakey Clamps

Box joint, atraumatic

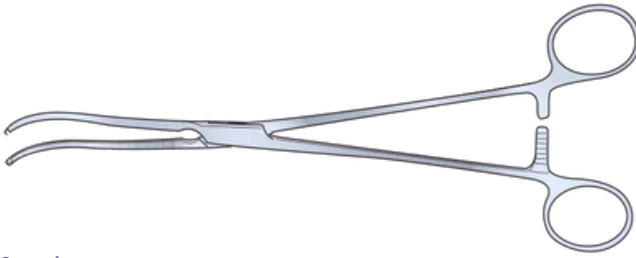

Curved

| Code | Description |
|-----------|-------------|
| SC-GI/088 | 230mm long |
| SC-GI/089 | 240mm long |
| SC-GI/090 | 245mm long |



DeBakey Clamps

Box joint, atraumatic

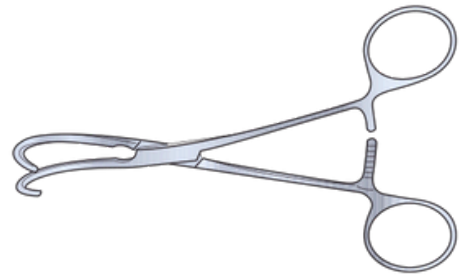

Curved

| Code | Description |
|-----------|-------------|
| SC-GI/094 | 150mm long |



DeBakey Clamps

Box joint, atraumatic

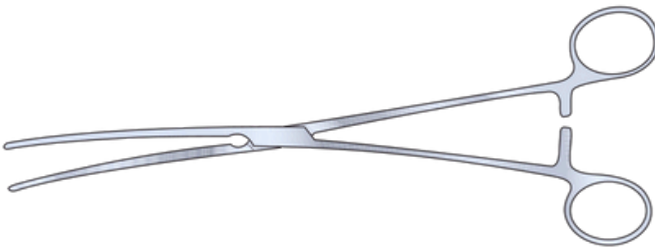

Curved

| Code | Description |
|-----------|-------------|
| SC-GI/091 | 250mm long |
| SC-GI/092 | 270mm long |
| SC-GI/093 | 280mm long |



DeBakey Clamps

Box joint, atraumatic

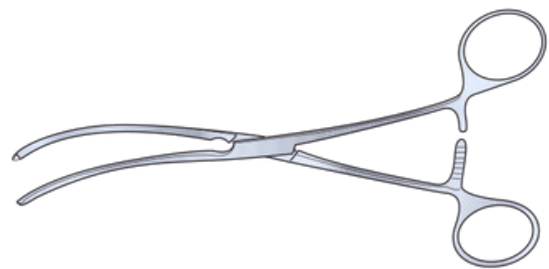

Curved

| Code | Description |
|-----------|-------------|
| SC-GI/096 | 180mm long |
| SC-GI/097 | 203mm long |



DeBakey Clamps

Box joint, atraumatic, straight

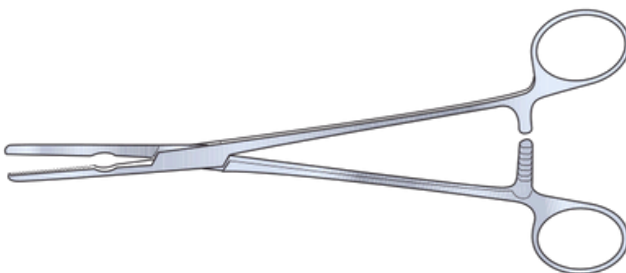

Curved

| Code | Description |
|-----------|-------------|
| SC-GI/100 | 160mm long |
| SC-GI/104 | 165mm long |
| SC-GI/101 | 203mm long |
| SC-GI/098 | 215mm long |
| SC-GI/102 | 220mm long |
| SC-GI/103 | 230mm long |
| SC-GI/099 | 245mm long |



DeBakey Clamps

Box joint, atraumatic

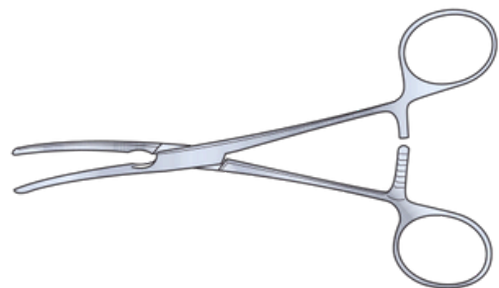

Curved

| Code | Description |
|-----------|-------------|
| SC-GI/080 | 165mm long |
| SC-GI/081 | 190mm long |
| SC-GI/082 | 203mm long |
| SC-GI/083 | 215mm long |
| SC-GI/084 | 220mm long |

Clamps

Duval Lung Grasping Clamps

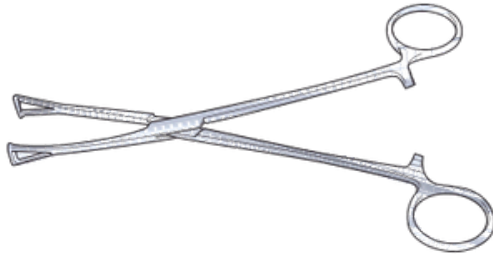

| Code | Description |
|------------|-------------|
| SC-THO/033 | 185mm long |

Tudor Edwards Artery Clamps

Curved, serrated jaws, screw joint, satin finish

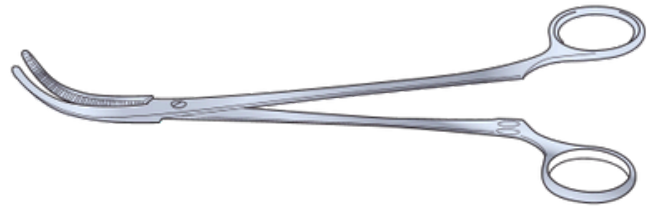

| Code | Description |
|------------|-------------|
| SC-THO/015 | 230mm long |

Babcock Lung Grasping Clamps

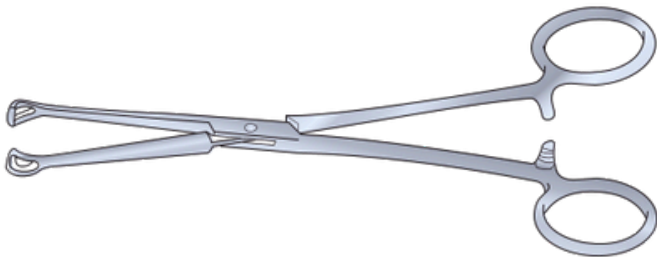

| Code | Description |
|------------|-------------|
| SC-THO/034 | 245mm long |

O'Shaughnessy Artery Clamps

Right angled serrated jaw

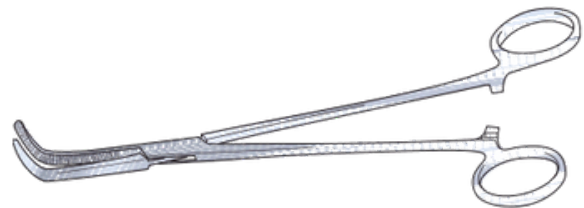

| Code | Description |
|-------------|-------------|
| SC-THO/036a | 150mm long |
| SC-THO/036b | 180mm long |
| SC-THO/036c | 200mm long |
| SC-THO/036d | 230mm long |

DeBakey Atraumatic Dissecting Clamps

Straight, atraumatic jaws

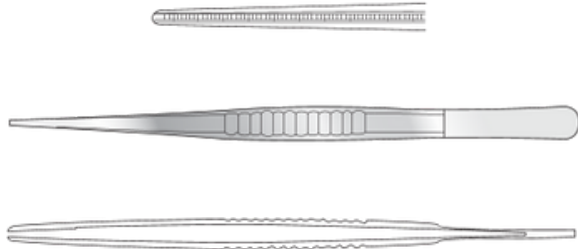

1.5mm

| Code | Description |
|------------|-------------|
| SC-GI/238a | 150mm long |
| SC-GI/240a | 240mm long |

2.5mm

| Code | Description |
|------------|-------------|
| SC-GI/238b | 150mm long |
| SC-GI/240b | 240mm long |

2mm

| Code | Description |
|-----------|--------------------|
| SC-GI/238 | 150mm |
| SC-GI/241 | long 180mm long |

2.8mm

| Code | Description |
|------------|-------------|
| SC-GI/238c | 150mm long |
| SC-GI/240c | 240mm long |
| SC-GI/241c | 180mm long |

Magill Intratracheal Catheter Clamps

Screw joint

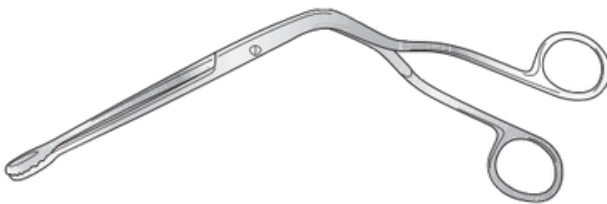

| Code | Description |
|-------------|--------------------|
| SC-THO/032 | Infant, 160mm long |
| SC-THO/032a | Child, 190mm long |
| SC-THO/032b | Adult, 230mm long |

SEMB Ligature Passing Clamps

240mm long

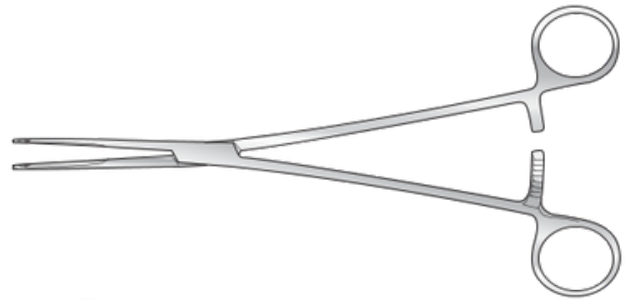

| Code | Description |
|------------|-----------------|
| SC-THO/044 | Slightly curved |
| SC-THO/045 | Fully curved |

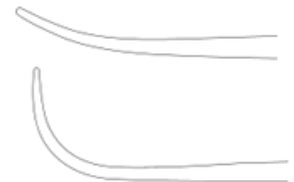

Lambert-Kay Clamp

Atraumatic



| Code | Description |
|-------------|----------------------|
| SC-THO/029a | Curved, 220mm long |
| SC-THO/029b | Straight, 215mm long |
| SC-THO/029c | Straight, 200mm long |

Leland-Jones Clamp

Atraumatic, hemostatic

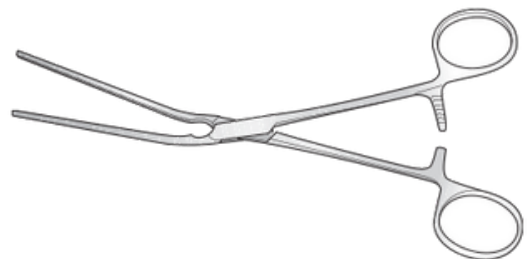

| Code | Description |
|-------------|----------------------|
| SC-THO/023a | Curved, 190mm long |
| SC-THO/023b | Straight, 195mm long |

DeBakey Clamp

Straight jaws, ring handle

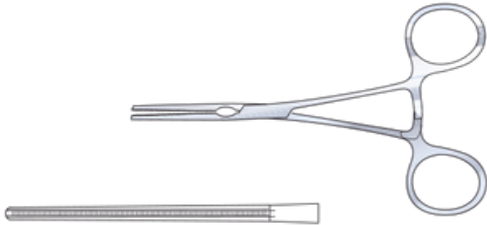

| Code | Description |
|------------|-------------|
| SC-THO/048 | 137mm long |

DeBakey Clamp

'S' shaped curved jaws, curved shaft, ring handle

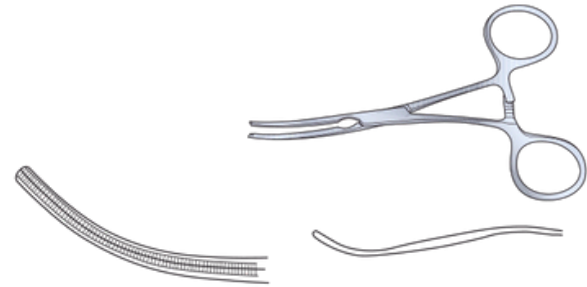

| Code | Description |
|------------|-------------|
| SC-THO/049 | 127mm long |

DeBakey "S" Shaped Clamp

300mm long

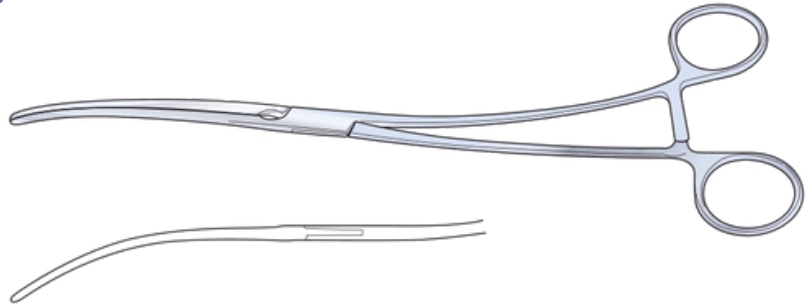

| Code | Description |
|------------|-------------|
| SC-THO/096 | 115mm jaws |

DeBakey Atraumatic Clamp

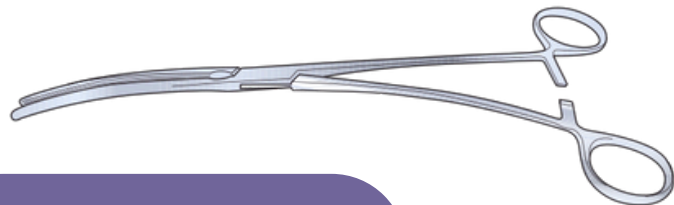

| Code | Description |
|------------|-----------------------|
| SC-THO/090 | 110mm jaw, 300mm long |
| SC-THO/092 | 95mm jaw, 250mm long |

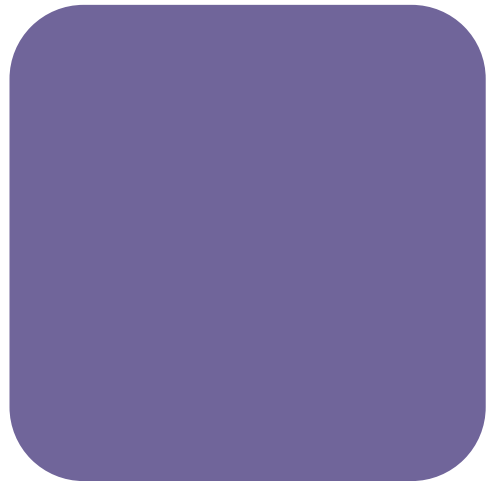

DeBakey Atraumatic Clamp

Right-angled, 40mm jaw

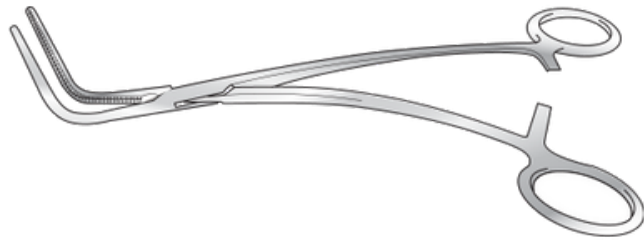

| Code | Description |
|-------------|-------------|
| SC-THO/044a | 220mm long |

DeBakey Atraumatic Clamp

Right-angled, 50mm jaw



| Code | Description |
|------------|-------------|
| SC-THO/045 | 200mm long |

DeBakey Atraumatic Clamp

Right-angled, 65mm jaw



| Code | Description |
|------------|-------------|
| SC-THO/046 | 215mm long |

DeBakey Atraumatic Clamp

Right-angled, 100mm jaw

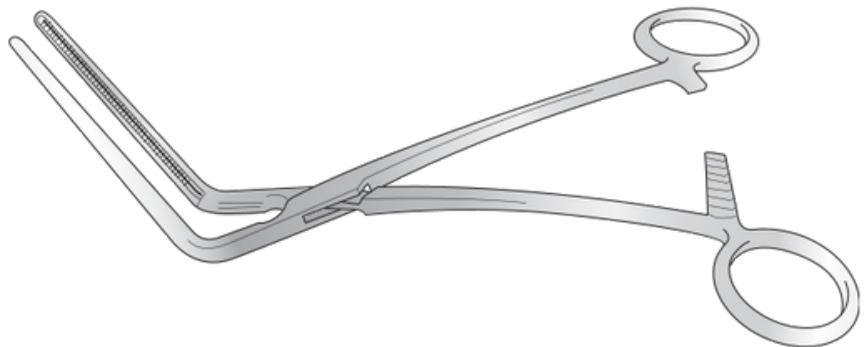

| Code | Description |
|------------|-------------|
| SC-THO/047 | 280mm long |

Clamps

DeBakey Coarctation Clamp

Angled, 225mm long

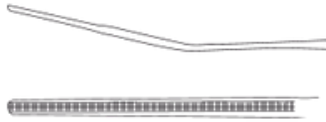

| Code |
|------------|
| SC-THO/052 |

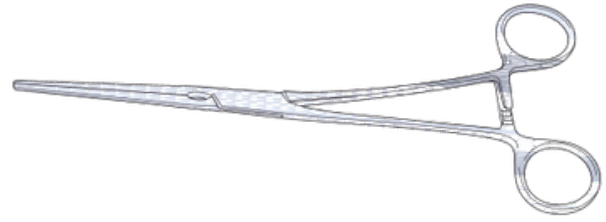

DeBakey Multipurpose Clamp



| Code | Description |
|------------|-----------------------|
| SC-THO/095 | 85mm jaw, 230mm long |
| SC-THO/064 | 100mm jaw, 280mm long |



DeBakey Multipurpose Clamp

Obtuse angled 60°, 280mm long

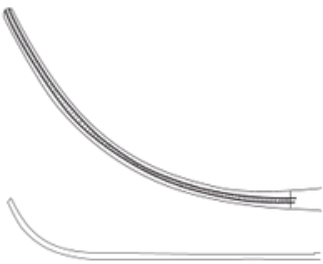

| Code |
|------------|
| SC-THO/053 |

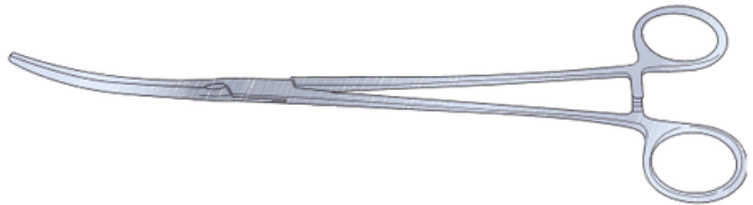

DeBakey 45° Paediatric Clamp

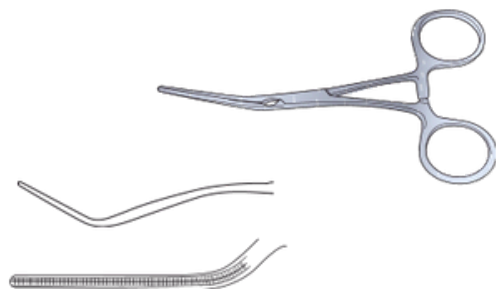

| Code | Description |
|------------|-------------|
| SC-THO/050 | 130mm long |

DeBakey 90° Paediatric Clamp

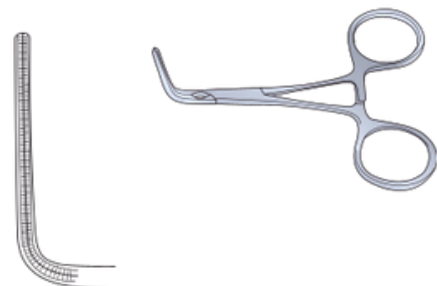

| Code | Description |
|------------|-------------|
| SC-THO/051 | 105mm long |

Die enbach Bulldog Clamp



Straight, serrated

| Code | Description |
|------------|---------------------------|
| SC-GI/112 | 1.2mm fine jaw, 40mm long |
| SC-GI/113 | 1.2mm fine jaw, 45mm long |
| SC-GI/108 | 1.8mm jaw, 30mm long |
| SC-GI/109 | 1.8mm jaw, 35mm long |
| SC-GI/110 | 2.5mm jaw, 40mm long |
| SC-GI/111 | 2.5mm jaw, 45mm long |
| SC-GI/107 | 6mm heavy jaw, 60mm long |
| SC-GI/455 | 20mm jaw, 75mm long |
| SC-GI/455a | 30mm jaw, 85mm long |
| SC-GI/455b | 45mm jaw, 105mm long |
| SC-GI/455c | 65mm jaw, 120mm long |

Straight, plain

| Code | Description |
|--------|---------------------------|
| SC- | 1.2mm fine jaw, 40mm long |
| GI/129 | 1.2mm fine jaw, 45mm long |
| SC- | 1.8mm jaw, 30mm long |
| GI/131 | 1.8mm jaw, 35mm long |
| SC- | 2.5mm jaw, 40mm long |
| GI/121 | 2.5mm jaw, 45mm long |
| SC- | |
| GI/123 | |
| SC- | |
| GI/125 | |
| SC- | |
| GI/127 | |

Curved, serrated

| Code | Description |
|-----------|---------------------------|
| SC-GI/119 | 1.2mm fine jaw, 40mm long |
| SC-GI/120 | 1.2mm fine jaw, 45mm long |
| SC-GI/115 | 1.8mm jaw, 30mm long |
| SC-GI/116 | 1.8mm jaw, 35mm long |
| SC-GI/117 | 2.5mm jaw, 40mm long |
| SC-GI/118 | 2.5mm jaw, 45mm long |
| SC-GI/114 | 6mm heavy jaw, 60mm long |
| SC-GI/456 | 20mm jaw, 75mm long |
| SC- | 30mm jaw, 85mm long |
| GI/456a | 45mm jaw, 105mm long |
| SC- | 65mm jaw, 120mm long |
| GI/456b | |
| SC- | |
| GI/456c | |

Curved, plain

| Code | Description |
|--------|---------------------------|
| SC- | 1.2mm fine jaw, 40mm long |
| GI/130 | 1.2mm fine jaw, 45mm long |
| SC- | 1.8mm jaw, 30mm long |
| GI/132 | 1.8mm jaw, 35mm long |
| SC- | 2.5mm jaw, 40mm long |
| GI/122 | 2.5mm jaw, 45mm long |
| SC- | |
| GI/124 | |
| SC- | |
| GI/126 | |
| SC- | |
| GI/128 | |

Blalock Bulldog Clamp



Serrated, with hole in handle

Straight

| Code | Description |
|-----------|---------------------|
| SC-GI/480 | 11mm jaw, 38mm long |
| SC-GI/482 | 14mm jaw, 48mm long |
| SC-GI/493 | 17mm jaw, 60mm long |
| SC-GI/481 | 27mm jaw, 70mm long |

Curved

| Code | Description |
|--------|---------------------|
| SC- | 11mm jaw, 38mm long |
| GI/478 | 14mm jaw, 48mm long |
| SC- | 17mm jaw, 60mm long |
| GI/479 | 27mm jaw, 70mm long |

SC-

GI/491

SC-

Curved

| Code | Description |
|-----------|---------------------|
| SC-GI/483 | 11mm jaw, 38mm long |
| SC-GI/484 | 14mm jaw, 48mm long |
| SC-GI/485 | 17mm jaw, 60mm long |
| SC-GI/490 | 27mm jaw, 70mm long |

Plain, with hole in handle

Straight

| Code | Description |
|-----------|---------------------|
| SC-GI/486 | 11mm jaw, 38mm long |
| SC-GI/487 | 14mm jaw, 48mm long |
| SC-GI/488 | 17mm jaw, 60mm long |
| SC-GI/489 | 27mm jaw, 70mm long |

Diethrich Bulldog Clamp

Angled 12mm jaw



| Code | Description |
|---------------|-------------|
| SC-JD-GI/8097 | 44mm long |

Scissors

Potts Scissors

Satin finish, 190mm long



| Code | Description |
|-------------|---------------------|
| SC-THO/019 | Angled on flat 45° |
| SC-THO/020a | Angled to side 45° |
| SC-THO/020b | Acute angle to side |

Potts Diethrich Scissors

Supercut, 190mm long



| Code | Description |
|---------------|--------------------|
| SC-T H O/07 8 | 25° angled on side |
| SC-T H O/07 9 | 45° angled on side |
| SC-THO/080 | 90° angled on side |

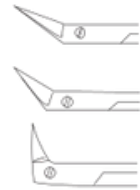

Diethrich Circumflex Artery Scissors

Supercut, 175mm long



| Code | Description |
|---------------|---------------------|
| SC-T H O/07 7 | 125° angled on side |

Boyd Scissor

Supercut, slight curve



| Code | Description |
|--------------|-------------|
| SC-T H O/047 | 180mm long |

Lobectomy Scissors

Curved on flat



| Code | Description |
|-------------|-------------|
| SC-THO/001b | 305mm long |

Nelson Lobectomy Scissor

Tungsten carbide, curved on flat, 230mm long



| Code |
|------------|
| SC-THO/057 |

Needle Holder and Wire Twister

For sternum wire, left-handed, 300mm long

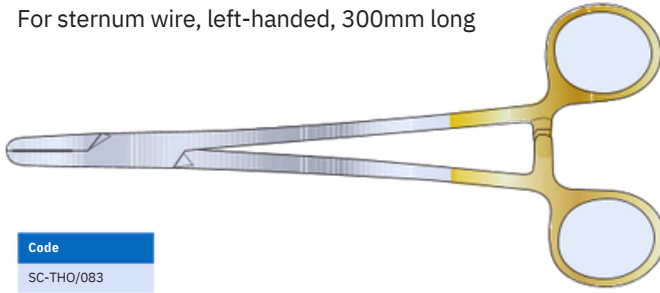

| Code |
|------------|
| SC-THO/083 |

Julian Needle Holder

Light, delicate model, with tungsten carbide jaws 220mm long

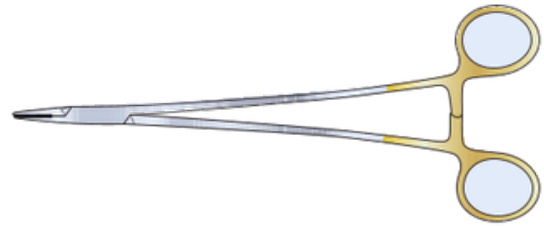

| Code | Description |
|-------------|-------------|
| SC-THO/081 | |
| SC-THO/081a | Left-handed |

Rochester Needle Holder

Light, delicate model, with tungsten carbide jaws 190mm long

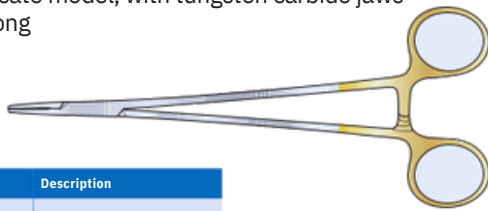

| Code | Description |
|-------------|-------------|
| SC-THO/082 | |
| SC-THO/082a | Left-handed |

DeBakey Needle Holder

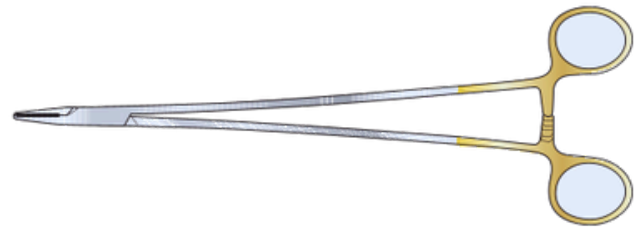

Stratte Needle Holder

210mm long

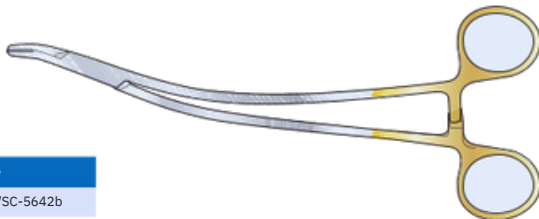

| Code |
|--------------|
| THO/SC-5642b |

| Code | Description |
|--------------|---|
| THO/SC-5642a | 250mm long 165mm very delicate 180mm |
| SC-GI/502A | tungsten carbide 260mm long straight with |
| SC-GI/502 | tungsten carbide inserts 240mm long Tungsten |
| SH003944 SC- | carbide delicate 230mm long Tungsten carbide |
| 5642A SC- | delicate 250mm long Tungsten carbide delicate |
| GI/036BM SC- | 305mm long |
| GI/037BM SC- | |
| GI/038BM | |

Castroviejo Needle Holder

| Code | Description |
|-----------|---------------------------|
| SC-OP/021 | 140mm long, with catch |
| SC-OP/020 | 140mm long, without catch |

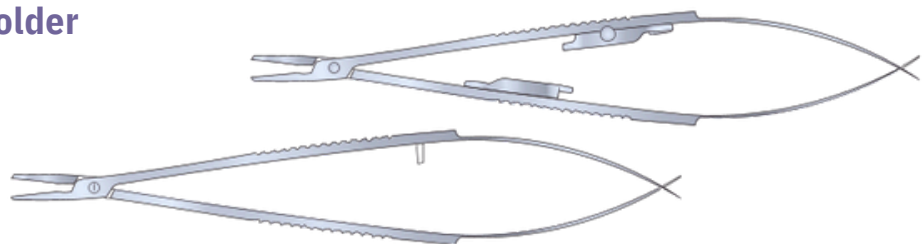

Diamond dust jaws

| Code | Description |
|------------|---------------------------|
| SC-THO/060 | 180mm long, without catch |
| SC-THO/061 | 200mm long, without catch |
| SC-THO/062 | 215mm long, without catch |

ALSO AVAILABLE WITH CATCH - ADD SUFFIX CTH TO CODE



Tungsten carbide jaws

| Code | Description |
|-------------|-------------|
| SC-THO/058a | 180mm long |
| SC-THO/058 | 200mm long |
| SC-THO/059 | 215mm long |

ALSO AVAILABLE WITH CATCH - ADD SUFFIX CTH TO CODE

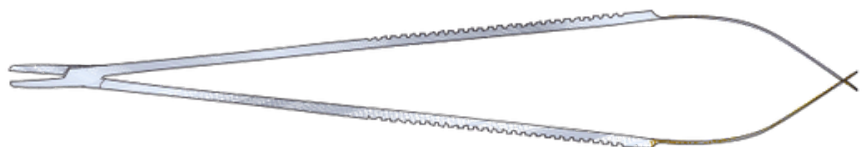

Retractors

Blanco Valve Leaflet Retractor

280mm long



| Code |
|------------|
| SC-THO/041 |

Harrington Splanchnic Retractor

Small size, end of blade 38mm wide x 127mm deep satin finish handle

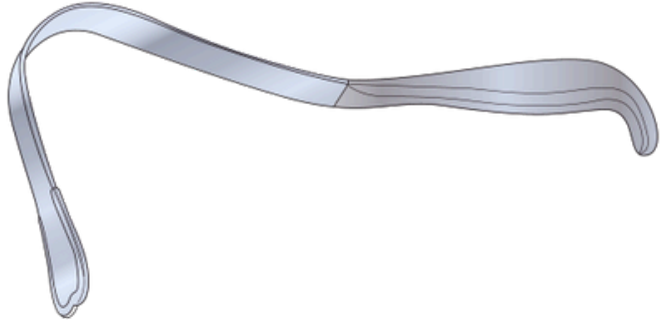

| Code | Description |
|------------|-------------|
| SC-THO/011 | 320mm long |

Brocks Erecton Spinal Back End Retractor

215mm long

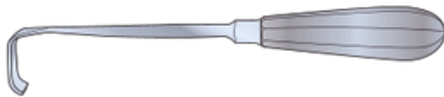

| Code | Description |
|------------|-------------|
| SC-THO/054 | 13 x 28mm |

Cleland Valve Leaflet Retractor

250mm long



| Code |
|------------|
| SC-THO/097 |

Ross Retractor

250mm long



| Code | Description | Code | Description |
|-------------|-------------------|-------------|-------------------|
| SC-THO/089 | 16mm x 15mm blade | SC-THO/089c | 27mm x 13mm blade |
| SC-THO/089a | 23mm x 13mm blade | SC-THO/089d | 27mm x 27mm blade |
| SC-THO/089b | 24mm x 16mm blade | SC-THO/089e | 25mm x 38mm blade |

Tudor Edwards Retractor

25mm Wide

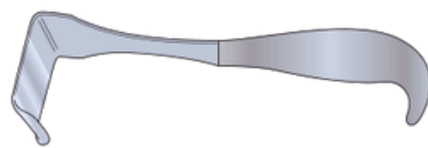

| Code | Description |
|------------|-------------|
| SC-THO/013 | 205mm long |

Allison Lung Retractor

Satin finish handle

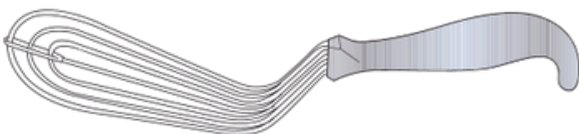

| Code | Description |
|-------------|--------------------|
| SC-THO/012a | Child, 280mm blade |
| SC-THO/012b | Adult, 300mm blade |

Cooley Atrial Retractor

260mm overall length

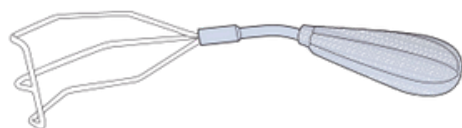

| Code | Description |
|-------------|-------------|
| SC-THO/046 | Right |
| SC-THO/046a | Left |

Finochietto Rib Spreader

Straight arms, 20mm square blades

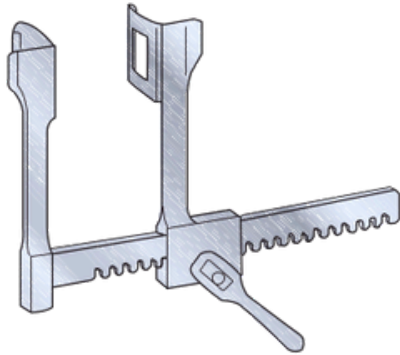

| Code | Description |
|------------|--|
| SC-THO/006 | Infant, maximum opening 80mm x 60mm long |
| SC-THO/037 | Adult, maximum opening 200mm, blades 44 x 65mm |

Morse-Favaloro Rib Spreader

Curved arms, 275mm long

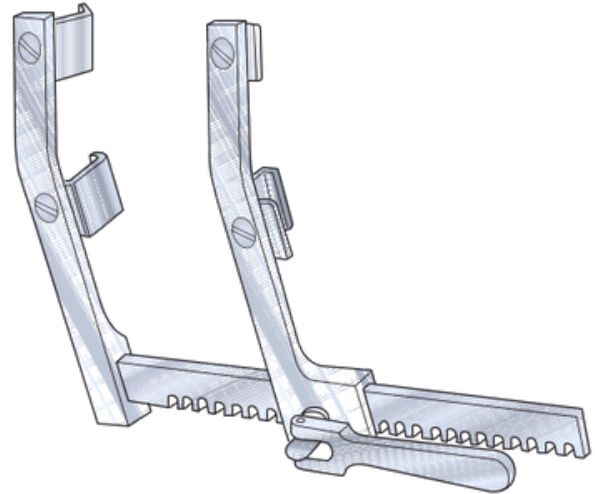

| Code | Description |
|-------------|-------------------------------|
| SC-THO/103 | Swivel blades 215mm |
| SC-THO/103a | long Swivel blades 185mm long |

IMA Rib Spreader

Converts left or right

| Code | Description |
|-------------|---|
| SC-THO/102 | Standard frame only |
| SC-THO/102a | Ministernotomy frame only |
| SC-THO/102b | Complete, standard, 1 x frame, 1 x 100mm long x 20mm wide U shaped blade, 1 x claw blades 28mm and 32mm deep |
| SC-THO/102c | Complete, ministernotomy, 1 x frame, 1 x 30mm long x 20mm wide U shaped blade, 1 x claw blades 43mm and 50mm deep |

Claw blade only

| Code | Description |
|-------------|-------------|
| SC-THO/102d | 28mm deep |
| SC-THO/102e | 32mm deep |
| SC-THO/102f | 38mm deep |
| SC-THO/102g | 43mm deep |
| SC-THO/102h | 50mm deep |

U shaped blade only

| Code | Description |
|-------------|------------------------|
| SC-THO/102i | 100mm long x 20mm wide |
| SC-THO/102j | 100mm long x 25mm wide |
| SC-THO/102k | 30mm long x 20mm wide |

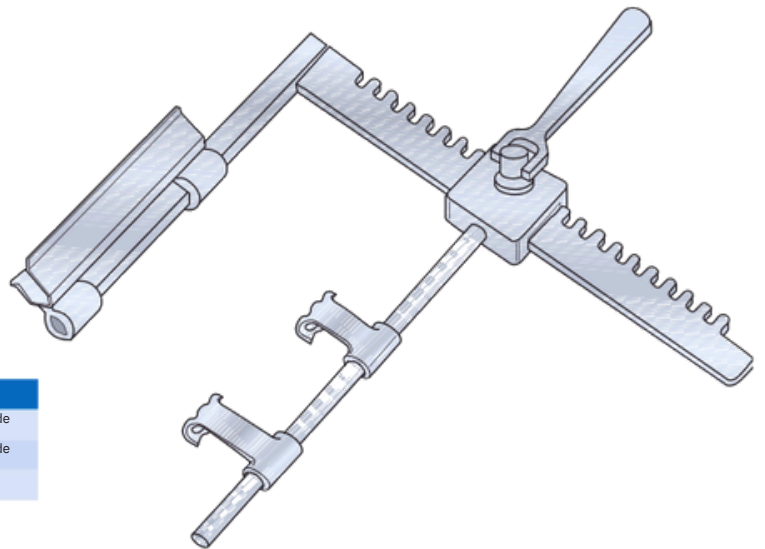

Price Thomas Rib Spreader

| Code | Description |
|------------|---|
| SC-THO/99 | Complete with 3 pairs of blades, key, 250, 215, 68mm |
| SC-THO/99a | Blade only, 50mm x 38mm, pair Blade only, 50mm x 45mm, pair Blade only, 50mm x 65mm, pair Nut and bolt for blade only Frame only Key only |
| SC-THO/99b | |
| SC-THO/99c | |
| SC-THO/99d | |
| SC-THO/99e | |
| SC-THO/99f | |

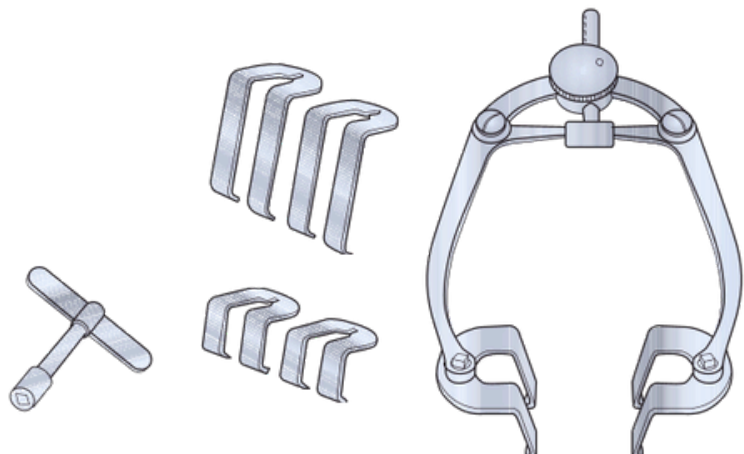

Rib Spreaders

Sellors Rib Spreader

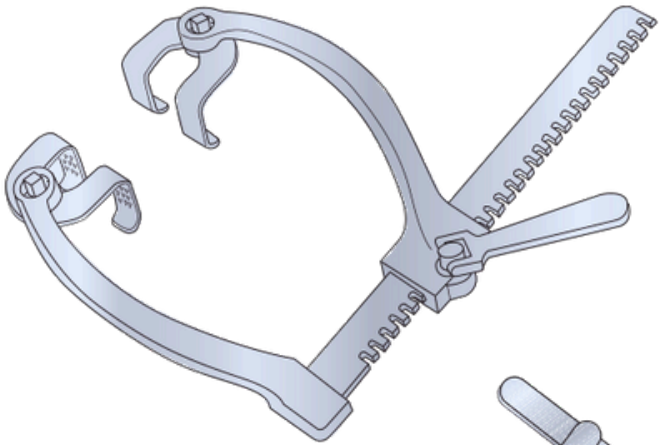

| Code | Description |
|-------------|---------------------------------------|
| SC-THO/100 | Complete with 3 pairs of blades, key, |
| SC-THO/100a | Blade only, 50mm x 38mm, pair Blade |
| SC-THO/100b | only, 50mm x 45mm, pair Blade only, |
| SC-THO/100c | 50mm x 65mm, pair Frame only Nut |
| SC-THO/100d | and bolt for blade only Key only |
| SC-THO/100e | |
| SC-THO/100f | |

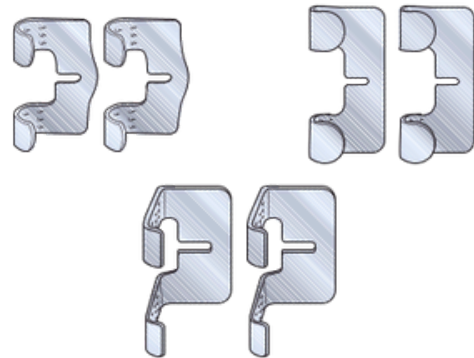

Harefield sternal blade only, pair

| Code | Description |
|-------------|-------------|
| SC-THO/100g | 70 x 30mm |
| SC-THO/100h | 120 x 30mm |

Harefield scapula blade only, pair

| Code | Description |
|-------------|-------------|
| SC-THO/100i | 75 x 70mm |

Ronald Edwards Rib Spreader

Curved arms, fenestrated

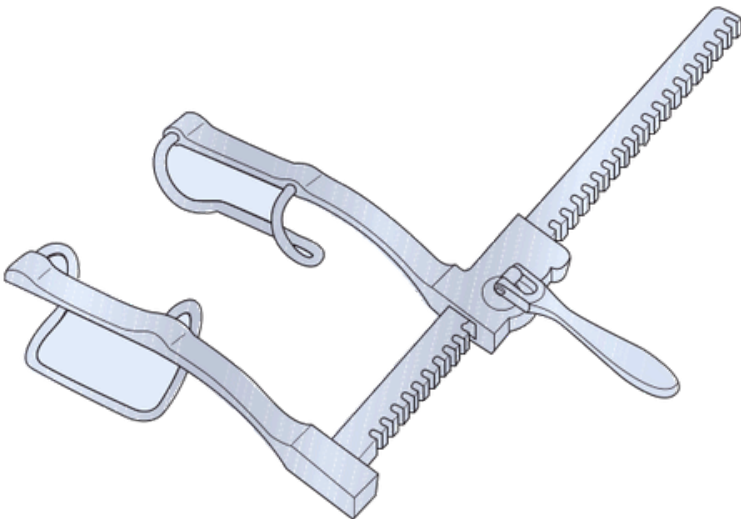

| Code | Description |
|------------|----------------------------------|
| SC-THO/104 | Infant, 100mm, 25mm x 30mm |
| SC-SH-5158 | blades Child, 150mm, 30mm x 50mm |
| SC-SH-5720 | blades Adult, 245mm, 65mm x 75mm |

blades

Bailey Rib Approximator and Spreader

Combined, satin finish

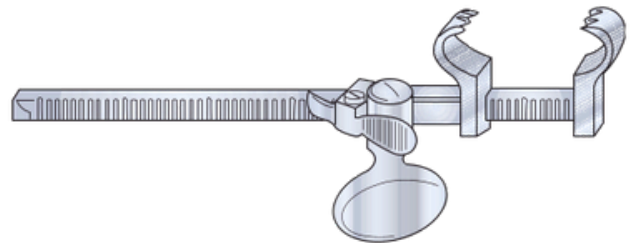

| Code | Description |
|------------|-------------|
| SC-THO/003 | 160mm long |

Sellors Rib Approximator and Spreader

Combined action, satin finish

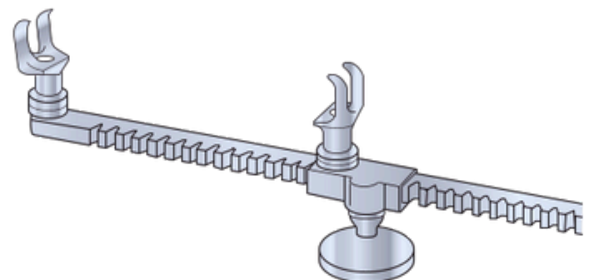

| Code | Description |
|------------|-------------|
| SC-THO/002 | 195mm long |

Cooley Rib Spreader

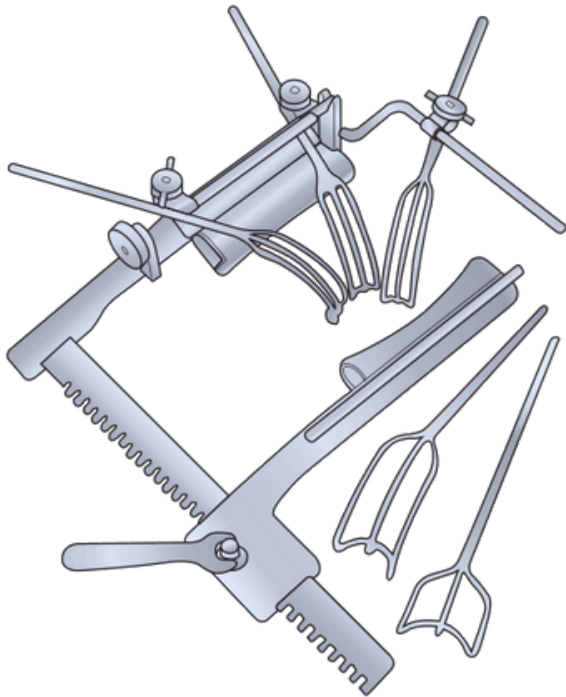

| Code | Description |
|-------------|---|
| SC-43950-50 | Adult, 40mm x 110mm blades, complete with cosgrove mounting bars |
| SC-43950-90 | Adult, 40mm x 110mm blades, complete with cosgrove mitral valve retractor attachment, 5 x blades, 3 x clamp, 1 x side arm |

Wells Rib Spreader

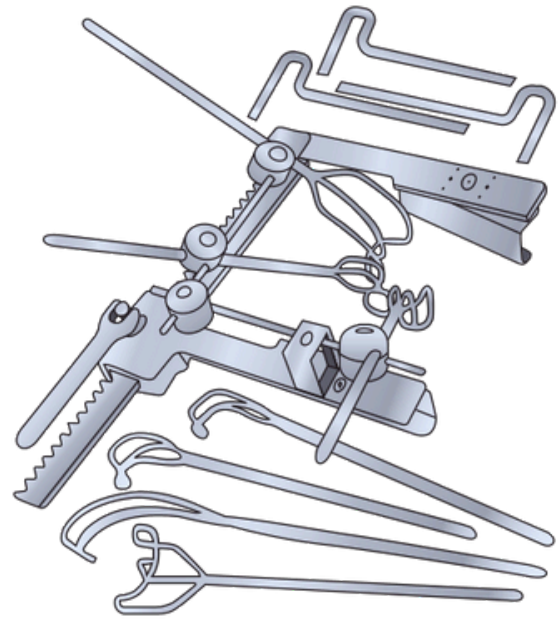

| Code | Description |
|-------------|---|
| SC-44080-65 | Small rake retractor on shaft |
| SC-44080-80 | Frame only, 90mm wide x 25mm deep blades |
| SC-44080-90 | Complete, frame, pillar clamp, 4 x ball clamps, 2 x mounting bars, hex keys, 1 x tricuspid rake ret, 2 x small, medium and large rake ret |

Tudor Edwards Rib Spreader

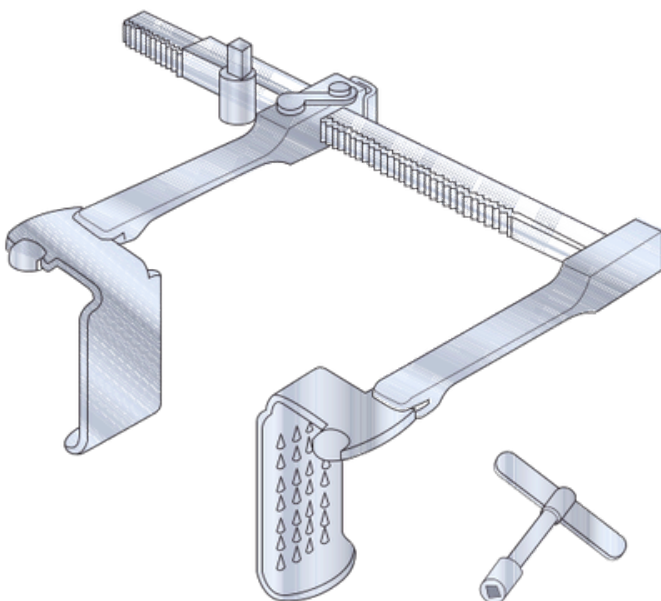

| Code | Description |
|------------|-------------------------------------|
| SC-THO/101 | Complete, 2 of each blade, plus key |
| SC- | 25mm blade only, pair |
| THO/101a | 50mm blade only, pair |
| SC- | 75mm blade only, pair |
| THO/101b | |

Tußer Rib Spreader

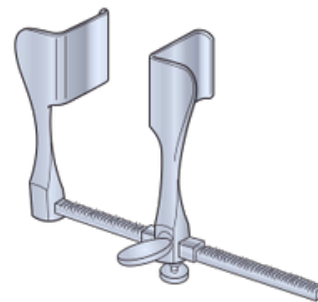

| Code | Description |
|------------|------------------------------|
| SC-THO/005 | Blades 25mm deep x 19mm wide |

Vehmehren Rib Holder and Costotome

Satin finish handles

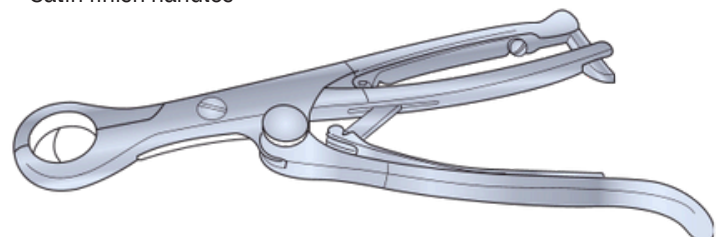

| Code | Description |
|------------|-------------|
| SC-THO/010 | 240mm long |

Rib Shears and Lung Forceps

Giertz Rib Shears

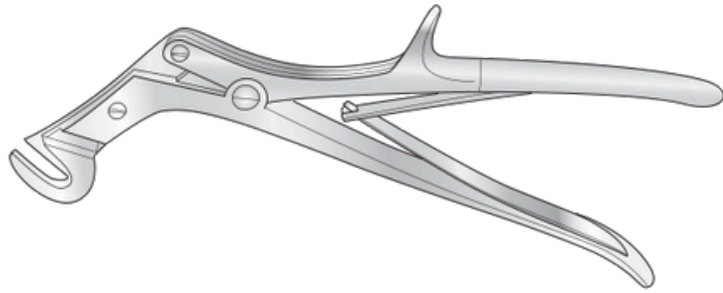

| Code | Description |
|-------------|-------------|
| SC-TH O/041 | 270mm long |

Tudor Edwards Rib Shears

Compound action, anterior



| Code | Description |
|-------------|-------------|
| SC-TH O/042 | 235mm long |

Mayo Lung Forceps

Fenestrated, semi-circular jaw, satin finish



| Code | Description |
|------------|-------------|
| SC-TH0/014 | 230mm long |

Tudor Edwards Periosteal Elevator

First rib, 175mm long

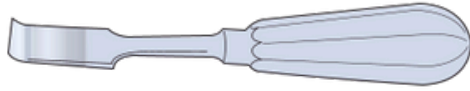

| Code | Description |
|-------------|-------------|
| SC-THO/009b | 18mm wide |

Doyen Periosteal Elevator

Satin finish handle

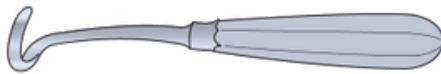

165mm long

| Code | Description |
|------------|-------------|
| SC-OR/N031 | Right |
| SC-OR/N032 | Left |

180mm long

| Code | Description |
|-----------|-------------|
| SC-OR/256 | Right |
| SC-OR/255 | Left |

Blalock Hook

249mm long



| Code | Description |
|-------------|--------------------|
| SC-THO/042 | 45° angle, 5mm tip |
| SC-THO/043b | 90° angle, 5mm tip |

Ross (Papworth) Ventricular Sucker

33mm long



| Code | Description |
|---------------|-------------|
| SC-THO/PAP001 | Bullet |

Ross (Papworth) Sump Sucker

42mm long

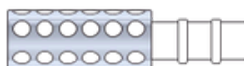

| Code | Description |
|---------------|-------------|
| SC-THO/PAP002 | Round end |

Ross (Papworth) Flat Sucker

42mm long



| Code |
|---------------|
| SC-THO/PAP003 |

Ross Probe

200mm long



| Code | Description |
|-------------|-------------|
| SC-THO/055 | 1mm |
| SC-THO/055a | 1.5mm |

Tibbs Arterial Cannula

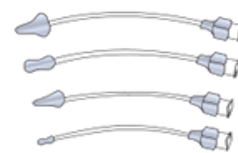

GU pattern

| Code | Description |
|------------|-------------|
| SC-TIB/001 | Set of four |
| SC-TIB/002 | Large cone |
| SC-TIB/003 | Large olive |
| SC-TIB/004 | Small cone |
| SC-TIB/005 | Small olive |

| Code | Description |
|------------|-------------|
| SC-TIB/006 | Large cone |
| SC-TIB/007 | Large olive |
| SC-TIB/008 | Small cone |
| SC-TIB/009 | Small olive |
| SC-TIB/010 | Set of four |

THANK YOU

Website: www.tetraind.com

Email: info@tetraind.com

WhatsApp: +92 329 7598399

Address: Shahab Pura 51310

Sialkot pakistan